

2019

CHOICE

**Course Selection Guide
Akoranga Whiringa Kaupapa**





2019

CHOICE

Course Selection Guide

Akoranga Whiringa Kaupapa

Welcome to Te Aho o Te Kura Pounamu

At the time of going to print the courses described in this guide are available for enrolment in 2019.

Refer to our website for the latest information on available courses, eligibility, standards and enrolment.

We may be required to withdraw or restrict enrolment to courses at any time. If you enrol in a course that is subsequently withdrawn or restricted in terms of enrolment, we will contact you to discuss other study options.

Information on NZQF standards are accurate at time of publication.

For more information, please contact us:

Website: www.tekura.school.nz

Email: info@tekura.school.nz

Freephone: 0800 65 99 88

We look forward to hearing from you.

Contents

Introduction		German	
Te Kupu Whakataki	5	Te Reo Tiamana	59
Early Childhood		Health Education	
Te Ratonga Kōhungahunga	14	Mātauranga Hauora	61
Years 1 to 6		History	
Tau 1 ki te 6	15	Kōrero Nehe	63
Years 7 to 10		Home Economics	
Tau 7 ki te 10	16	Te Mātauranga Ohaoha Kāinga	66
Special Education/Learning Support		Japanese	
Te Akoranga Motuhake	17	Te Reo Hapanihi	68
Big Picture		Kaupapa Māori	
Big Picture	19	Kaupapa Māori	70
Subjects at a glance		Legal Studies	
Summary of subjects and levels of study	20	Te Akoranga Taha Ture	72
Accounting		Mathematics and Statistics	
Te Mātauranga Mahi Kaute	22	Te Mātauranga Pāngarau	74
Art		Media Studies	
Te Mātauranga Toi	24	Te Akoranga Pāpāho	78
Art History		Music	
Te Toi Hitori	28	Te Mātauranga Pūoru	80
Biology		Pathways Education	
Te Mātauranga Koiora	30	Te Mātauranga Rapuara	82
Business Studies		Performing Arts	
Ngā Akoranga Umanga	32	Ngā mahi ā te Rēhia	85
Chemistry		Physical Education	
Te Mātauranga Matū	34	Mātauranga Hākinakina	86
Chinese		Physics	
Te Reo Hainamana	36	Te Mātauranga Ahupūngao	88
Classics and Religious Studies		Primary Production (Agriculture/Horticulture)	
Te Akoranga Puāwaitanga me ngā Hāhi	38	Te Ahumahi Matua	90
Commerce Studies		Samoan	
Te Mātauranga Tauhokohoko	40	Te Reo Hāmoa	93
Design and Visual Communication		Science	
Ngā mahi hoahoa me te Whakawhitiwhiti ataata	42	Te Mātauranga Pūtaiao	94
Digital Technology		Social Studies	
Te Hangarau Mamatai	44	Te Akoranga Tikanga ā-iwi	98
Economics		Spanish	
Te Mātauranga Ōhanga	47	Te Reo Pāniora	99
English		Technology	
Te Reo Ingarihi	49	Te Mātauranga Hangarau	101
Enterprise Studies		Te Reo Māori	
Ngā Akoranga Hinonga	53	Te Reo Māori	104
French		Tertiary Link/Huarahi Trades Academy	
Te Reo Wīwī	54	Te Wānanga Hononga/Huarahi	107
Gateway/STAR		Index	
Ngā Pokenga Mahi/STAR	56	Te Kupu Tohu	108
Geography			
Te Mātauranga Mātai Matawhenua	57		

Introduction

Te Kupu Whakataki

Te Aho o Te Kura Pounamu (Te Kura) is a distance education provider. We offer a wide range of personalised learning programmes and courses from early childhood to NCEA Level 3. This guide is designed to help students plan a programme of learning at Te Kura. It is particularly intended for students from Year 7 and above, as their programmes of learning increasingly include more detailed study in some learning areas. All courses are based on The New Zealand Curriculum.

Our learning programmes include the use of online technology. Our school has a secure, online learning environment called My Te Kura. Online courses typically include a mix of interactive activities such as quizzes, digital resources including audio and video files, and activities students can work on away from the computer. Teachers maintain an active presence online communicating with students, supervisors and whānau and providing feedback on work completed.

We accept enrolments throughout the year, from students of all ages. To find out about our enrolment criteria please visit our website www.tekura.school.nz, email enrolment@tekura.school.nz or call us on 0800 65 99 88 option 1.

Selecting and planning your programme of learning

Early Childhood – Te Rotonga Kōhungahunga

Our Early Childhood programme supports learning at home in the early years. Qualified Te Kura teachers work with students and whānau to share information and develop a programme of learning within the guidelines of Te Whākariki – The New Zealand Early Childhood Curriculum. Resources include posted materials and online learning. This free service is for students aged from 2 to 6 years. Read more on page 14.

Years 1 to 6 – Tau 1 ki te 6

Te Kura's primary learning programme for students in schooling Years 1–6 is based on the key competencies and eight learning areas of The New Zealand Curriculum. Students are allocated a learning advisor (teacher) who works closely with the student and their whānau to develop a personalised programme based on their interests, abilities and learning needs.

Students may wish to learn through theme-based cross-curricular projects in an area of interest or based around the student's daily life. The student and their whānau work with their learning advisor to decide on the theme and scope of a project, and appropriate teaching and assessment. This programme of learning uses a mix of online learning and print delivery. Read more on page 15.

Years 7 to 10 – Tau 7 ki te 10

Full-time Year 7–10 students are enrolled in Te Ara Hou, an integrated programme of learning that is based on the key competencies and eight learning areas of The New Zealand Curriculum. Students have a learning advisor who will work with a student and their whānau to develop a personalised, individual learning plan that is based on the student's interests and goals and keeps options open for future study at NCEA level 1.

Students may wish to learn through theme-based cross-curricular projects in an area of interest or based around the student's daily life. The student and their supervisor work with their learning advisor to decide on the theme and scope of a project, and appropriate teaching and assessment. Modules of learning are delivered online through Tō Kupenga in Te Kura's online learning environment or through Google Classroom. Read more on page 16.

Years 11 to 13 – Tau 11 ki te 13

Full-time Year 11 to 13 students' learning programmes are based on their individual learning plan. Students will have a learning advisor who will help them set goals and explore their interests, to determine their subjects and maintain options for future study that link to career opportunities.

Students will have the opportunity to participate in Big Picture learning. This approach to learning focuses on the learner's passions and goals for life beyond school. It uses these as a basis for a learning plan that is unique to each student. A student may be working across NCEA levels and in subjects that support their interests. Students will have the chance to explore opportunities in their community, which may include internships and tertiary exploration, as well as working towards a relevant qualification. Learning is delivered through Te Kura's online learning environment.

Young adults (16–19 years)

Students who have left school and are aged between 16 and 19 (and not turning 20) in the study year for which they are enrolling can enrol with Te Kura free of charge in one or more subjects. We have a range of subjects available for enrolment. Most enable students to earn credits towards national qualifications. Young adults enrolled in three or more courses will have a learning advisor who will help them plan a full programme of study through an individual learning plan.

Students will also have the opportunity to participate in Big Picture learning. This approach to learning focuses on the learner's passions and goals for life beyond school. It uses these as a basis for a learning plan that is unique to them. Students will have the chance to explore opportunities in their community, which may include internships and tertiary learning experiences, as well as working towards a relevant qualification. Learning is delivered through Te Kura's online learning environment.

Adult students

Adult students can enrol in one or more courses. Most courses are designed as one-year courses, but a learner may work faster or slower than this. Many courses offer a range of options. Student support advisors and subject teachers will assist students with their choices. Learning is delivered through Te Kura's online learning environment.

Special Education/Learning Support – Te Akoranga Motuhake

Some students studying with Te Kura have learning support needs and require significant adaptation of the curriculum. We design a programme to match the needs, interests and context of the individual. We aim to meet their long and short-term goals. Learning Support courses are open to all students in the compulsory education years and to adults. Early childhood students with learning support needs are taught by our early childhood service. Read more about Learning Support on page 17.

Dual students

Students enrolled in New Zealand schools and with other education providers (e.g. Teen Parent Units, Alternative Education) may also be eligible for registration for courses with Te Kura. Dual tuition arrangements are between that provider and Te Kura.

The Dual Provider Partnership Agreement, which sets out the responsibilities of both providers, can be found on Te Kura's website www.tekura.school.nz/dual-providers/first-steps/dual-provider-partnership

Dual registrations for students are made online by the student's primary provider through the Te Kura Enrolment System. Registrations are accepted throughout the year and open on 26 November for the 2019 school year.

Schools are expected to ensure students are enrolled in the course at the most appropriate curriculum level. Some courses require prior study. Schools must also ensure that students enrolled in courses delivered online have access to the required hardware, software and internet.

Further information is available on our website www.tekura.school.nz/dualproviders

Fees

If a student meets the Ministry of Education's criteria for enrolling with us, there are no school fees. Adult students pay an administration fee.

In some circumstances students who do not meet Ministry of Education eligibility criteria for a funded place may be able to enrol with Te Kura as a fee-paying student. Fees are on a per-course basis. Students already enrolled at another school must be registered and the fee paid by their home school.

To find out more, visit our website at www.tekura.school.nz or contact Te Kura's Student and Whānau Support team on 0800 65 99 88 option 1 or email enrolment@tekura.school.nz

Equipment required for online learning

Every student enrolled in an online course needs a suitable device and access to the internet. For advice about getting set up for learning online, visit our website www.tekura.school.nz/learn-with-us/get-started or contact Te Kura's Student and Whānau Support team, phone 0800 65 99 88 option 2 or email hub@tekura.school.nz.

Device and connectivity assistance

Te Kura offers a device and an internet subsidy of \$30 per month to eligible students. Students must be a current full-time student, or a young adult student enrolled in three or more online courses.

Applicants will be a student, or individuals financially responsible for a student, who receive a benefit from Work and Income or have a Community Services Card. The applicant and student must reside in New Zealand.

Additional connectivity assistance of \$30 per month is available for an eligible student who is enrolled through the gateway of geographic inaccessibility, geographic isolation, or itinerancy.

Students who withdraw from Te Kura must return the device. The internet subsidy is \$30 per month during the school year and is paid directly into the applicant's bank account. The subsidy will cease as soon as the student is no longer enrolled with Te Kura.

Applications for assistance open on 8 January 2019. You can apply online or download an application form on our website at www.tekura.school.nz. Or, an application can be made over the telephone by calling our Student and Whānau Support team on 0800 65 99 88 option 2.

Qualifications

Under the New Zealand Qualifications Framework (NZQF), it is possible to build a programme of learning so that credits attained can contribute to more than one qualification. At Te Kura, we offer the NCEA certificates at Levels 1–3, as well as other national certificates, so it is possible for students to work towards more than one qualification at the same time. Detailed information about these qualifications can be found on our website or the New Zealand Qualifications Authority (NZQA) website at www.nzqa.govt.nz.

NZQA fees

Students studying courses that offer assessment against Achievement and/or Unit Standards which count towards NCEA must pay a NZQA fee each year. This fee is \$76.70, although students may be eligible for financial assistance that will reduce the fee. Payments made after 31 October must be paid direct to NZQA prior to 1 December to avoid an additional late fee of \$50.

National Certificate of Educational Achievement

Students enrolling in a one-year National Certificate of Educational Achievement (NCEA) course should aim to achieve 18–20 credits. This requires about 200 hours of student study time.

It is important students take advice from their teacher, learning advisor and/or student support staff so they choose a balanced programme of learning that matches their aspirations and abilities. A suitable learning programme may include courses across multiple curriculum or NCEA levels.

To gain **NCEA Level 1**, a student must have 80 credits. These credits can be made up of unit standards and achievement standards at any level, including a literacy and numeracy requirement.

To gain **NCEA Level 2**, a student must have 80 credits.

- 60 of these must be from standards at Level 2 or above.
- 20 credits at Level 1 or above may have already been counted for Level 1 and still count towards a Level 2 certificate.

They must also meet the NCEA Level 1 literacy and numeracy requirements.

To gain **NCEA Level 3**, a student must have 80 credits.

- 60 of these must be from standards at Level 3 or above.
- 20 credits at Level 2 or above may have already been counted for Level 2 and still count towards a Level 3 certificate.

They must also meet the NCEA Level 1 literacy and numeracy requirements.

Literacy and numeracy requirements

Standards offered at Te Kura that count towards NCEA Level 1 literacy and numeracy requirements are identified in the course descriptions in this book.

- **Literacy** – either a minimum 10 credits through a package of three literacy unit standards or a minimum of 10 credits through specified achievement standards.
- **Numeracy** – either a minimum 10 credits through a package of three numeracy unit standards or a minimum of 10 credits through specified achievement standards.

For a full list of literacy and numeracy standards see www.nzqa.govt.nz/ncea/subjects/literacy-and-numeracy/level-1-requirements/

Course endorsement

Students will gain course endorsement with merit if, in a calendar year, they gain 14 or more credits at merit and/or excellence in a course.

They will gain course endorsement with excellence if, in a calendar year, they gain 14 or more credits at excellence in a course.

These must include at least three credits from externally assessed standards and at least three credits from internally assessed standards in that course.

Some courses offer only externally assessed or internally assessed standards and are therefore not eligible for endorsement.

Certificate endorsement

A student can gain NCEA certificates endorsed with merit or excellence. A NCEA certificate endorsed with merit is awarded if they gain 50 credits at merit level (or a mix of merit and excellence) across courses. A NCEA certificate endorsed with excellence is awarded if they gain 50 credits at excellence level across courses.

University Entrance

To be awarded University Entrance (UE) a student must have:

- NCEA Level 3
- three subjects at Level 3 or above made up of:
 - 14 Achievement Standard credits each, in three approved subjects. (For a full list of approved subjects see www.nzqa.govt.nz/qualifications-standards/awards/university-entrance/approved-subjects/)
 - Literacy – 10 credits at Level 2 or above made up of:
 - five credits in reading
 - five credits in writing
 - Numeracy – 10 credits at Level 1 or above made up of:
 - Achievement Standards (specified achievement standards available through a range of subjects) or Unit Standards (package of three numeracy unit standards).

Standards available at Te Kura that count towards UE literacy and numeracy requirements are identified in the course descriptions in this book. (For a full list of UE literacy and numeracy standards see www.nzqa.govt.nz/qualifications-standards/awards/university-entrance/)

Vocational Pathways

Vocational Pathways provide ways to achieve NCEA Levels 1–3 and develop pathways that progress to further study, training and employment. Achieving NCEA Level 2 is the foundation for success in further education and the world of work. Level 3 builds upon this through shared opportunities across school, tertiary, and industry training.

The Vocational Pathways provide a framework for students to show how their learning and achievement is valued in the workplace by aligning learning to the skills needed for industry.

The six Vocational Pathways are:

- Primary Industries
- Construction and Infrastructure
- Manufacturing and Technology
- Social and Community Services
- Services Industries
- Creative Industries.

To obtain a Vocational Pathways Award, a student needs to gain NCEA Level 2, including:

- 60 Level 2 credits from recommended standards from a Vocational Pathways sector, including 20 credits from sector-related standards for that sector. To achieve these, they will need to be part of our Gateway or Huarahi (Te Kura's Trades Academy) and participate in relevant STAR programmes.

Vocational Pathways Award(s) will show on a student's NZQA Record of Achievement.

Level 3 Achievement Standards and current Levels 3–7 local, national, and New Zealand qualifications have been mapped to Vocational Pathways to provide students with an ongoing pathway. The maps help students intending to study towards NCEA Level 3 and other Level 3 qualifications to make informed choices about their study options in relation to the type of degree-level study they wish to pursue.

For more information, talk to your learning advisor or visit www.youthguarantee.net.nz

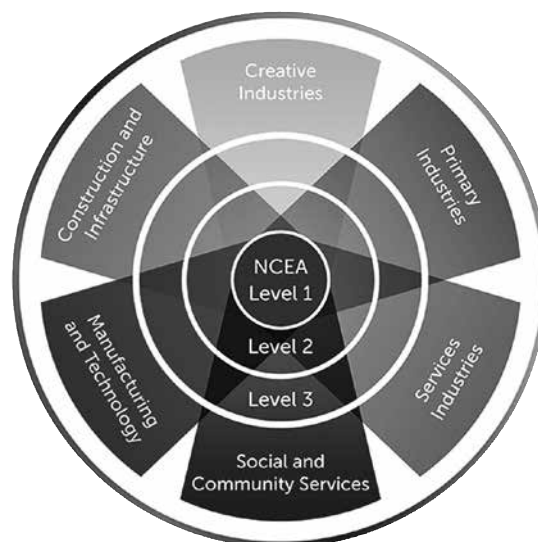

Vocational Pathways wheel diagram © New Zealand Ministry of Education. Used by permission.

National Certificates

Credits gained towards NCEA are automatically counted towards National Certificates by NZQA. Te Kura offers a wide range of National Certificates, some of which are completed through partnerships – such as Gateway, Trades Academies and work placements.

STAR

Secondary Tertiary Alignment Resources (STAR), are short taster courses offered through Polytechnics and Private Training Organisations. Each Te Kura region has a secondary–tertiary advisor who, alongside the learning advisor, organises these programmes for students.

Gateway

Gateway is a structured, work-based learning programme for students aged 16–19 years in an industry of the student's choice. Te Kura's Gateway coordinator will work out a programme with the student that includes work-based learning that can be assessed. Students can gain credits while also working towards NCEA, for one term or longer. Gateway is not necessarily linked to a Polytech or other tertiary provider.

How to use this guide

The information in this guide is also available online. Refer to www.tekura.school.nz for the most up-to-date information.

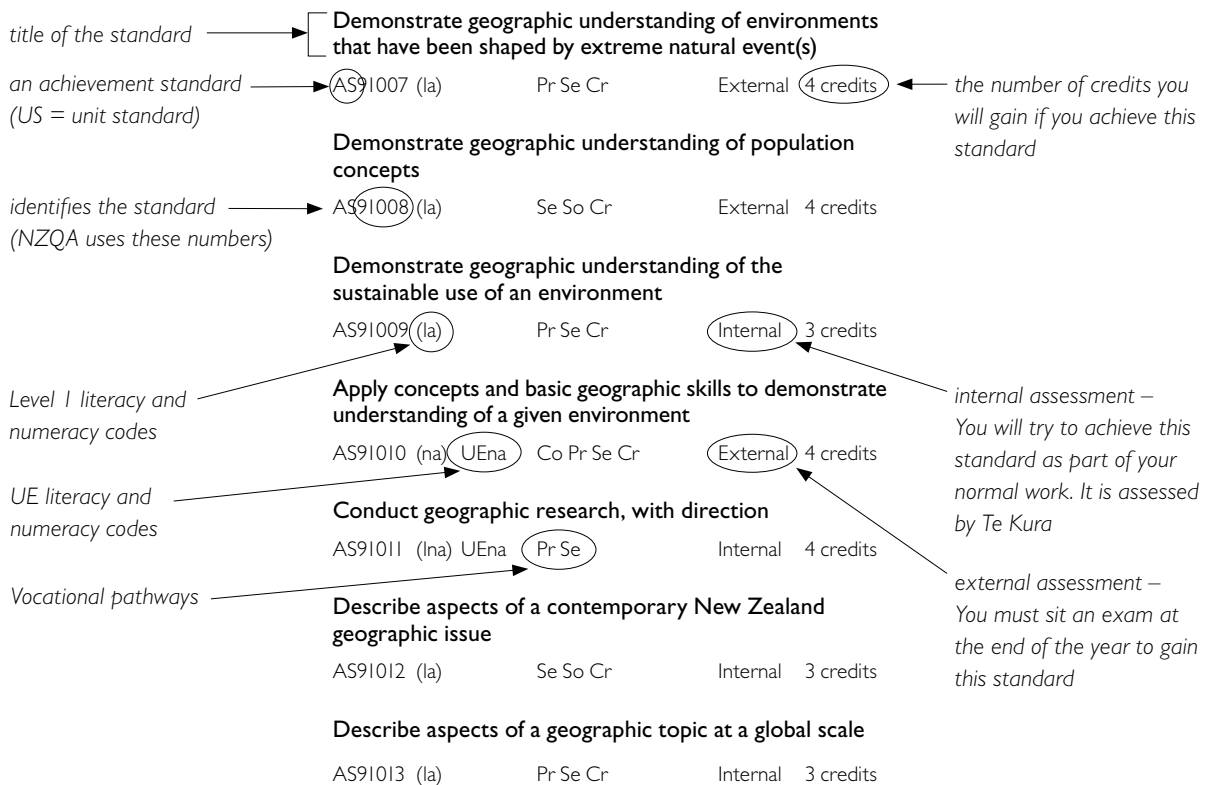
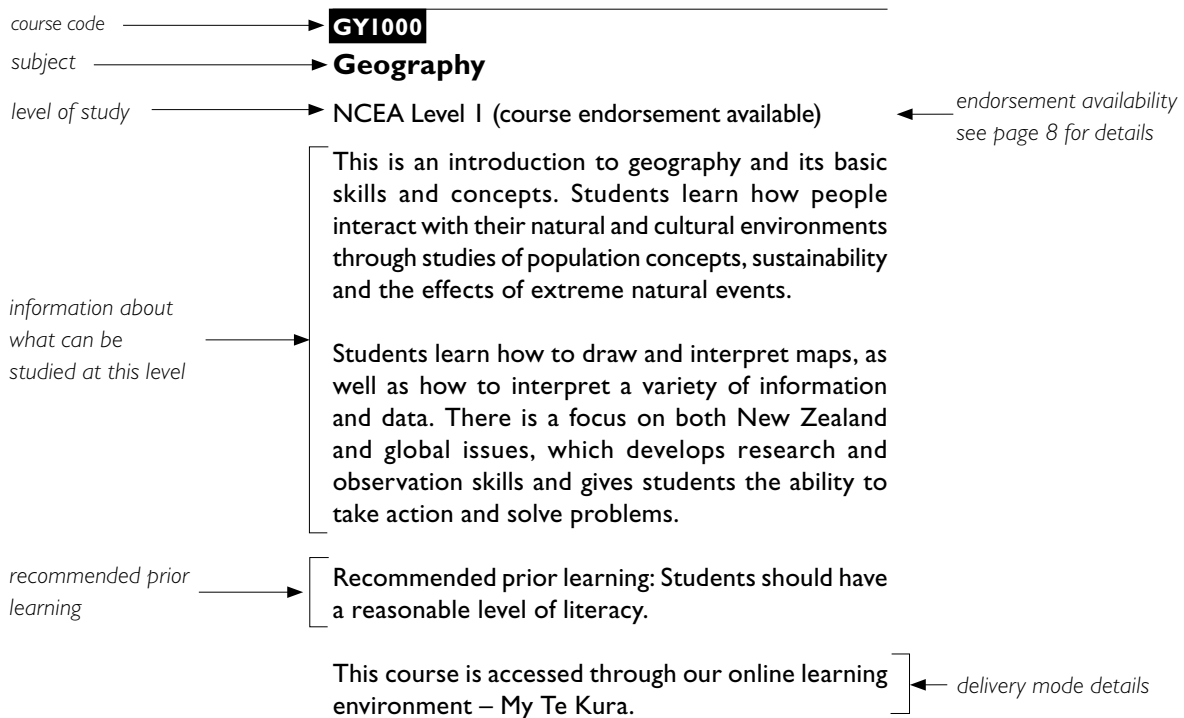

NCEA Level I Literacy and Numeracy requirements

For details of these requirements, please refer to the NZQA website –

www.nzqa.govt.nz/ncea/subjects/literacy-and-numeracy/level-I-requirements/

Standards that count towards these requirements are identified as below

- (la) Literacy achievement standard
- (na) Numeracy achievement standard
- (lna) Literacy and numeracy achievement standard
- (nu) Numeracy unit standard
- (lu) Literacy unit standard

University Entrance literacy and numeracy requirements

For details of these requirements, please refer to the NZQA website –

www.nzqa.govt.nz/qualifications-standards/awards/university-entrance/

Standards that count towards these requirements are identified as below

- (UEna) UE numeracy achievement standard
- (UEnu) UE numeracy unit standard
- (UElwa) UE literacy writing achievement standard
- (UElra) UE literacy reading achievement standard
- (UElwra) UE literacy writing and reading achievement standard
- (UEnlra) UE numeracy and literacy reading achievement standard
- (UEnlwa) UE numeracy and literacy writing achievement standard
- (UEnlwra) UE numeracy, literacy writing and literacy reading achievement standard

Vocational Pathways requirements

For details of these requirements, please refer to

<http://youthguarantee.net.nz/vocational-pathways/>

You can access this website directly or from your NZQA learner login.

Standards that count towards these requirements are identified as below

- Co Construction and Infrastructure recommended standard
- SCo Construction and Infrastructure sector-related standard
- Ma Manufacturing and technology recommended standard
- SMa Manufacturing and technology sector-related standard
- Pr Primary Industries recommended standard
- SPr Primary Industries sector-related standard
- Se Service Industries recommended standard
- SSe Service Industries sector-related standard
- So Social and Community Services recommended standard
- SSo Social and Community Services sector-related standard
- Cr Creative Industries recommended standard
- SCr Creative Industries sector-related standard

Early Childhood

Te Ratonga Kōhungahunga

The Early Childhood Service offers a high-quality, personalised early education programme to children aged from 2–6 years. The programme works within the guidelines of *Te Whāriki – He whāriki mātauranga mō ngā mokopuna o Aotearoa*, the New Zealand Early Childhood Curriculum.

PRINCIPLES

EMPOWERMENT | WHAKAMANA

HOLISTIC DEVELOPMENT | KOTAHITANGA

FAMILY AND COMMUNITY | WHĀNAU TANGATA

RELATIONSHIPS | NGĀ HONONGA

STRANDS

WELLBEING | MANA ATUA

BELONGING | MANA WHENUA

CONTRIBUTION | MANA TANGATA

COMMUNICATION | MANA REO

EXPLORATION | MANA AOTŪROA

Through the programme, whānau, parents (or caregivers) and teachers work in partnership to share information about children's learning and development, with this knowledge informing the development of the child's programme of learning. Resources including books, art materials and manipulative resources are sent with each posting as well as offering online learning, which enhance the relationships and sense of belonging for children and whānau and extend upon learning opportunities for children.

The programme is free of charge and children can attend a licensed early childhood centre for up to eight hours per week and still qualify for Te Kura.

Years 1 to 6

Tau I ki te 6

Te Kura's primary learning programme for students in Years 1–6 is based on the key competencies and the eight learning areas of The New Zealand Curriculum. Students are allocated a learning advisor (teacher) who works closely with the student and their whānau to develop a personalised programme based on their interests, abilities and learning needs.

An Individual Learning Plan is developed together, with the student's aspirational goals recorded. Regular reviews of the student's learning plan are made, measuring progress against goals, and with opportunities to set new goals. Students may wish to learn through theme-based cross-curricular projects in an area of interest or based around the student's daily life. The student and their whānau work with their learning advisor to decide on the theme and scope of a project, and appropriate teaching and assessment. This programme of learning uses a mix of online learning through My Primary in Te Kura's online learning environment, through Google Classroom and through print delivery.

Students can contact their learning advisor via email, Skype, our online learning environment or by telephone and post. Students will also have the opportunity to meet their learning advisor or other Te Kura teachers at event days and other organised activities throughout the year.

Enrolment criteria

Te Kura provides distance education for students living in New Zealand and overseas, from early childhood level through to Year 13.

You may be able to enrol with us if you meet certain eligibility criteria set by the Ministry of Education. Check your eligibility on our website at www.tekura.school.nz/enrol/, or call 0800 65 99 88

The New Zealand Curriculum		
Vision Young people who will be confident, connected, actively involved, lifelong learners.		
Values Excellence; Innovation, inquiry and curiosity; Diversity; Equity; Community and participation; Ecological sustainability; Integrity; Respect.	Key competencies Thinking; Using language, symbols and texts; Managing self; Relating to others; Participating and contributing.	Learning areas English; the Arts; Health and Physical education; Learning languages; Mathematics and statistics; Science; Social Sciences; Technology.
Principles High expectations Treaty of Waitangi Cultural diversity Inclusion Learning to learn Community engagement Coherence Future focus		

Years 7 to 10

Tau 7 ki te 10

Full-time Year 7–10 students are enrolled in Te Ara Hou, an integrated programme of learning that is based on the key competencies and eight learning areas of The New Zealand Curriculum. Students are allocated a learning advisor who will work with a student and their whānau to develop a personalised programme that is based on the student's interests and goals, and keeps options open for future study at NCEA level 1.

An Individual Learning Plan is developed together, with the student's aspirational goals recorded. Regular reviews of the student's learning plan are made, measuring progress against goals, and with opportunities to set new goals. Students may wish to learn through theme-based cross-curricular projects in an area of interest or based around the student's daily life. The student and their supervisor work with their learning advisor to decide on the theme and scope of a project, and appropriate teaching and assessment. Modules of learning are delivered online through Tō Kupenga in Te Kura's online learning environment, through Google Classroom and through print delivery.

Students can contact their learning advisor via email, Skype, our online learning environment or by telephone and post. Students will also have the opportunity to meet their learning advisor or other Te Kura teachers at event days and other organised activities throughout the year.

Enrolment criteria

Te Kura provides distance education for students living in New Zealand and overseas, from early childhood level through to Year 13.

You may be able to enrol with us if you meet certain eligibility criteria set by the Ministry of Education. Check your eligibility on our website at www.tekura.school.nz/enrol/, or call 0800 65 99 88.

The New Zealand Curriculum		
Vision Young people who will be confident, connected, actively involved, lifelong learners.		
Values Excellence; Innovation, inquiry and curiosity; Diversity; Equity; Community and participation; Ecological sustainability; Integrity; Respect.	Key competencies Thinking; Using language, symbols and texts; Managing self; Relating to others; Participating and contributing.	Learning areas English; the Arts; Health and Physical education; Learning languages; Mathematics and statistics; Science; Social Sciences; Technology.
Principles High expectations Treaty of Waitangi Cultural diversity Inclusion Learning to learn Community engagement Coherence Future focus		

Special Education/Learning Support

Te Akoranga Motuhake

Some students studying with Te Kura have special education needs and require significant adaptation of the curriculum. We therefore design a programme to match the needs, interests and context of an individual. We aim to meet their long and short-term goals. The courses offered under this programme are all at Curriculum Level 1. There are also two Life Skills courses at Curriculum Level 1. There is an additional Life Skills course at Curriculum Levels 2–3. Special Education courses are open to all students in the compulsory education years and to adults. Early childhood students with special education needs are enrolled and taught by our Early Childhood Service.

SLS100

Supported Learning Standards

Curriculum Level 1

Supported Learning Standards are intended for students at Year 10 and above working with support at Curriculum Level 1.

Students can work towards achieving the National Certificate in Work and Community Skills (40 credits) provided they commenced achieving Supported Learning Standards before the beginning of 2018.

Throughout this course, students develop skills and knowledge in three domains i.e. personal care, interpersonal and social skills, work and community skills (this domain includes communication and numeracy).

If it is felt that a student would benefit from aspects of this course due to their psychological or physical condition, even though they are working above Curriculum Level 1 in other subject areas, consideration will be given by the curriculum leader of Learning Support who may approve enrolment on a case-by-case basis.

Students must have the support of a teacher aide who acts as the supervisor for the assessments.

Please note: This life skills qualification is expiring, the last date to meet requirements is 31 December 2019.

Recommended prior learning: No prior learning needed.

Identify and locate organs in the human body, in a supported learning context

US11854 Internal 2 credits

Demonstrate knowledge of self-care for minor illness or condition, and injury, in a supported learning context

US11860 Internal 2 credits

Demonstrate knowledge of personal hygiene, in a supported learning context

US11861 Internal 3 credits

Cross roads safely, in a supported learning context

US11865 Internal 4 credits

Answer a phone call and refer a phone call, in a supported learning context

US11867 Internal 2 credits

Make phone calls, in a supported learning context

US11869 Internal 1 credits

Purchase goods in a shop, in a supported learning context

US11876 Internal 1 credits

Select and wear clothes for different occasions and identify need to care for clothes, in a supported learning context

US11877 Internal 1 credits

Grow and care for plants, in a supported learning context

US11879 Internal 2 credits

Prepare and serve a light meal, in a supported learning context

US11882 Internal 4 credits

Handle money, in a supported learning context

US11888 Internal 3 credits

Make deposits into and withdrawals from own bank account, in a supported learning context

US11889 Internal 2 credits

Use a calculator to assist with functional numeracy, in a supported learning context

US11890 Internal 2 credits

Demonstrate functional knowledge of measuring length, in a supported learning context

US11891 Internal 3 credits

Demonstrate functional knowledge of measuring weight, in a supported learning context	US11893	Internal	3 credits
Demonstrate functional knowledge of measuring time, in a supported learning context	US11894	Internal	4 credits
Use a calendar, in a supported learning context	US11896	Internal	2 credits
Identify and use numbers one to ten in everyday life, in a supported learning context	US11897	Internal	2 credits
Identify and use numbers ten to one hundred in everyday life, in a supported learning context	US11898	Internal	3 credits
Produce, save, and print a text document on a computer, in a supported learning context	US11900	Internal	4 credits
Receive, record, and deliver messages, in a supported learning context	US11914	Internal	2 credits
Clarify and follow received instructions, in a supported learning context	US11918	Internal	2 credits
Identify traditional occasions in own family, in a supported learning context	US11921	Internal	2 credits
Demonstrate knowledge of friendships or relationships, in a supported learning context	US20075	Internal	3 credits

LS100

Life Skills

Curriculum Level 2–3

This Life Skills course provides opportunities to develop skills for everyday living and can lead into further study in Pathways education. The learning materials and experiences are ideal for students in Years 9 and 10.

This course focuses on developing knowledge and skills to assist with everyday living. The units of work include: preparation for employment, preparing a CV, job interview skills, goal setting, budgeting, shopping, time management, filling in forms, interpersonal and social skills, accessing information in maps and timetables, using public transport, computing and communication technology.

Recommended prior learning: No prior learning needed.

This course is accessed through our online learning environment – My Te Kura.

Big Picture

Big Picture

Design your own programme of learning to support your interests and passions. The starting point is YOU.

What are you interested in, what are your dreams for yourself and your future? Your Learning Advisor will help you explore your interests and options and create a personalised programme for you, supported by whanau and others, which will include exploring opportunities in your own community (and beyond if you want to).

Add to your NCEA options by choosing standards from a range of areas that connect to the programme of learning you have designed. Explore cross-curricular learning supported by your Learning Advisor where NCEA standards can fall out of projects and interest explorations.

Through Big Picture Learning you have the opportunity to build on your prior learning and experience and to develop new skills and insights driven by your own interests and passions. As part of this exploration you may attend a range of STAR courses, plan a work-placement with Gateway, and possibly be part of Huarahi, our Te Kura Trades Academy, which partners with providers across the country.

There are many opportunities to develop and apply the skills and knowledge you'll develop through Big Picture Learning in authentic contexts in your own community, through work exploration leading to job shadowing, internships, secondary-tertiary opportunities, and future education and employment opportunities.

BP9000**Big Picture**

Curriculum Levels 4–8

Subjects at a glance

Summary of subjects and levels of study

Detailed information follows in this guide. Refer to www.tekura.school.nz for the most up-to-date information.

Subject	Up to Curriculum Level 5	NCEA Level 1	NCEA Level 2	NCEA Level 3
Accounting		Accounting	Accounting	Accounting
Agriculture	See Primary Production			
Art (visual)	Visual Arts	Visual Arts	Visual Arts	Painting
				Design
				Sculpture
				Printmaking
			Photography	
Art History			Art History	Art History
Biology		Biology	Biology	Biology
Business Studies		Business Studies	Business Studies	
Chemistry		Chemistry	Chemistry	Chemistry
Chinese (Mandarin)	Chinese (beginners)	Chinese	Chinese	Chinese
Classical Studies			Classical Studies	Classical Studies
			Religious Studies	Religious Studies
Commerce Studies		Commerce Studies	Commerce Studies	
Design and Visual Communication	Design and Visual Communication	Design and Visual Communication	Design and Visual Communication	Design and Visual Communication
Digital Technology	Digital Technology	Digital Technology	Digital Technology	Digital Technology
Early Childhood	Early Childhood			
Economics		Economics	Economics	Economics
English	English	English	English	English
Enterprise Studies	Enterprise Studies			
French	French (beginners)	French	French	French
Gateway		Gateway	Gateway	Gateway
Geography		Geography	Geography	Geography
German	German (beginners)	German	German	German
Health Education	Health Education	Health Education	Health Education	Health Education
History		History	History	History (England)
				History (New Zealand)
Home Economics	Home Economics	Home Economics	Home Economics	Home Economics
Horticulture	See Primary Production			
Japanese	Japanese (beginners)	Japanese	Japanese	Japanese
Kaupapa Māori		Kaupapa Māori	Kaupapa Māori	Kaupapa Māori
Legal Studies		Legal Studies	Legal Studies	Legal Studies
Life Skills	Life Skills			

Subject	Up to Curriculum Level 5	NCEA Level 1	NCEA Level 2	NCEA Level 3
Mathematics	Mathematics and Statistics	Mathematics and Statistics	Mathematics and Statistics	Calculus
				Statistics
				Mathematics
Media Studies		Media Studies	Media Studies	Media Studies
Music	Music	Music	Music	Music
Pathways Education		Pathways Education	Pathways Education	
		Pregnancy and Childcare	Pregnancy and Childcare	
Performing Arts		Dance	Dance	Dance
Physics		Physics	Physics	Physics
Physical Education	Physical Education	Physical Education	Physical Education	Physical Education
Primary (Years 0–6)	Primary			
Primary Production	Primary Production	Primary Production	Primary Production	Primary Production
Samoan		Samoan		
Science	Science	Science	Science (selection)	Science (selection)
Social Studies	Social Studies			
Spanish	Primary Spanish	Spanish	Spanish	Spanish
	Spanish (beginners)			
Special Education Programme	Special Education			
Te Ara Hou (Years 7–10)	Te Ara Hou			
Technology	Technology	Technology	Technology	Technology
Te Reo Māori	Primary Te Reo Māori	Te Reo Māori	Te Reo Māori	Te Reo Māori
	Te Reo Māori (beginners)			

Accounting

Te Mātauranga Mahi Kaute

Accounting is fundamental for business and for everyday life. Students gain financial literacy and the tools to make real-life financial decisions in a changing and uncertain world. One of the vital skills students learn is how to prepare and communicate financial information to a wide range of people. Further study can lead to a career in accounting in many diverse businesses worldwide. With a business or commerce degree, you can keep your options wide open.

AC1000

Accounting

NCEA Level 1 (course endorsement available)

Financial literacy is an essential lifelong skill. This course gives students the tools to make real-life financial decisions in a range of situations. Students develop the knowledge and skills to manage the financial affairs of individuals, community organisations and sole traders. There is an emphasis on preparing financial information and effectively communicating that information.

Recommended prior learning: Students should have a reasonable level of literacy.

This course is accessed through our online learning environment – My Te Kura.

Demonstrate understanding of accounting concepts for small entities

AS90976 (la) Pr Se Cr External 3 credits

Process financial transactions for a small entity

AS90977 Se Cr Internal 5 credits

Prepare financial statements for sole proprietors

AS90978 Se Cr External 5 credits

Prepare financial information for a community organisation's annual general meeting

AS90979 (la) Se Cr Internal 4 credits

Interpret accounting information for sole proprietors

AS90980 (la) Pr Se Cr External 4 credits

Make a financial decision for an individual or group

AS90981 (la) Se Cr Internal 3 credits

Demonstrate understanding of cash management for a small entity

AS90982 (la) Se Cr Internal 4 credits

AC2000

Accounting

NCEA Level 2 (course endorsement available)

This course builds on the knowledge already gained in Level 1. It has a strong focus on accounting for sole traders and is useful for people interested in running their own business. Students gain further knowledge, skills and experience needed to manage a small business, including the basics of managing inventory and accounts receivable processes. Students process and interpret financial transactions and then, more importantly, report on this financial information. A practical segment using the accounting software MYOB is also included.

Recommended prior learning: Students should have a reasonable level of literacy.

This course is accessed through our online learning environment – My Te Kura.

Demonstrate understanding of accounting concepts for an entity that operates accounting subsystems

AS91174 (la) Se Cr External 4 credits

Demonstrate understanding of accounting processing using accounting software

AS91175 (na) UEna Se Cr Internal 4 credits

Prepare financial information for an entity that operates accounting subsystems

AS91176 (na) UEna Cr External 5 credits

Interpret accounting information for entities that operate accounting subsystems

AS91177 (lna) UEna Cr External 4 credits

Demonstrate understanding of an accounts receivable subsystem for an entity

AS91179 (lna) UEna Cr Internal 3 credits

Demonstrate understanding of an inventory subsystem for an entity

AS91386 (lna) UEna SSe Internal 3 credits

Demonstrate understanding of a contemporary accounting issue for decision-making

AS91481 (la) Cr Internal 4 credits

AC3000**Accounting**

NCEA Level 3 (course endorsement available)

Students develop knowledge from previous levels within the context of companies and partnerships. Students gain knowledge, skills and experience in using management for effective decision making. Students report, analyse and interpret information for partnerships, manufacturing businesses and companies. Accounting NCEA Level 3 and Scholarship prepares students for tertiary education. New Zealand Scholarship exams are designed to extend very high-achieving Level 3 students. Those who wish to enter the New Zealand Scholarship exam in this subject must discuss this option with their Te Kura subject teacher.

Recommended prior learning: Students should have a reasonable level of accounting knowledge.

This course is accessed through our online learning environment – My Te Kura.

Demonstrate understanding of accounting concepts for a New Zealand reporting entity

AS91404 (la) UElra External 4 credits

Demonstrate understanding of accounting for partnerships

AS91405 (na) UEna Internal 4 credits

Demonstrate understanding of company financial statement preparation

AS91406 (na) UEna External 5 credits

Prepare a report for an external user that interprets the annual report of a New Zealand reporting entity

AS91407 (lna) UEnlwra Internal 5 credits

Demonstrate understanding of management accounting to inform decision-making

AS91408 (lna) UEna External 4 credits

Demonstrate understanding of a job cost subsystem for an entity

AS91409 (lna) UEna Internal 4 credits

Art

Te Mātauranga Toi

Visual arts is a subject that allows students to express and develop their creativity, while developing their knowledge and skills. Students create their own artworks while learning about the work of other artists and the cultural and social contexts that these artworks reflect. Students can study visual arts to gain qualifications or to explore their interest in art.

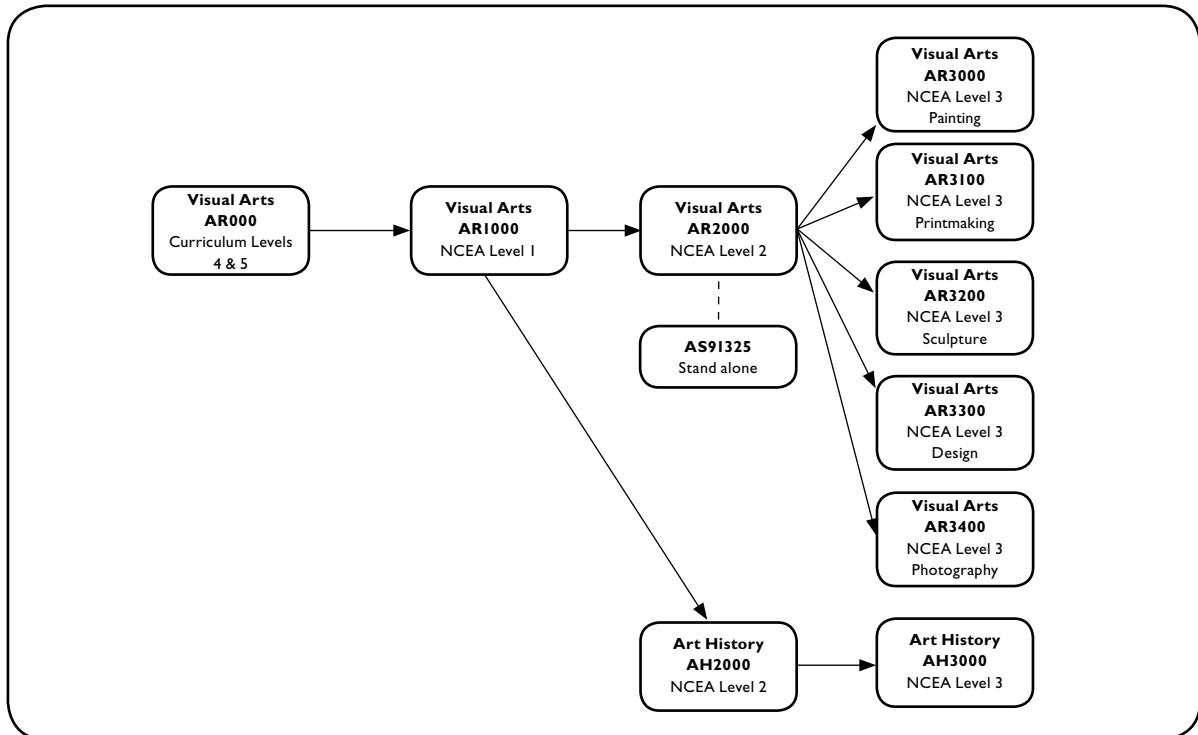

AR000

Visual Arts

Curriculum Levels 4–5

Students are given an introduction to drawing, painting, sculpture and design using a variety of techniques and media. An awareness of the process of developing artistic ideas from start to finish is introduced, and students can plan an appropriate programme to meet their needs and interests in art. Year 10 students can further develop skills and knowledge appropriate for moving forward to NCEA qualifications at Year 11.

Recommended prior learning: No prior learning needed.

This course is accessed through our online learning environment – My Te Kura.

AR1000

Visual Arts

NCEA Level 1 (course endorsement available)

This is the first of the NCEA art courses. It enables students to develop ideas and creative approaches to making artworks in a range of fields. Students' work is informed by their research of New Zealand artists from Māori, Polynesian and European traditions. Students can work towards an individual standard or multiple standards including developing a body of work for the external folio standard.

Recommended prior learning: Curriculum Levels 4–5 Art or equivalent.

This course is accessed through our online learning environment – My Te Kura.

Demonstrate understanding of art works from a Māori and another cultural context using art terminology

AS90913 (1a)

Se Cr

Internal 4 credits

Use drawing methods and skills for recording information using wet and dry media
AS90914 Cr Internal 4 credits

Use drawing conventions to develop work in more than one field of practice
AS90915 Cr Internal 6 credits

Produce a body of work informed by established practice, which develops ideas, using a range of media
AS90916 Cr External 12 credits

Produce a finished work that demonstrates skills appropriate to cultural conventions
AS90917 Se Cr Internal 4 credits

AR2000

Visual Arts

NCEA Level 2 (course endorsement available)

From a foundation of NCEA Level 1 Visual Arts, students continue to critically develop ideas and creative approaches to making artworks. Students can produce a body of work in Painting by completing multiple internal standards and the portfolio external standard. Alternatively, students can undertake two internal standards in Photography and/or Design.

For students not wanting to complete a full art programme, it is possible, with the consultation of the senior teacher, to undertake AS91325: Produce a resolved work that demonstrates control of skills appropriate to cultural conventions, (Visual Arts 2.5) as a single, standalone standard in any art discipline. This opportunity particularly suits students with existing interest and skills, a passion project or artisan mentor relationship. Projects should strongly identify with a specific culture or subculture located within a specific tradition or convention.

Recommended prior learning: NCEA Level 1 Visual Art course or equivalent.

This course is accessed through our online learning environment – My Te Kura.

Demonstrate an understanding of methods and ideas from established practice appropriate to painting
AS91306 (1a) Se SCr Internal 4 credits

Use drawing methods to apply knowledge of conventions appropriate to design
AS91310 SCr Internal 4 credits

Use drawing methods to apply knowledge of conventions appropriate to painting
AS91311 SCr Internal 4 credits

Use drawing methods to apply knowledge of conventions appropriate to photography
AS91312 SCr Internal 4 credits

Develop ideas in a related series of drawings appropriate to established design practice
AS91315 SCr Internal 4 credits

Develop ideas in a related series of drawings appropriate to established painting practice
AS91316 SCr Internal 4 credits

Develop ideas in a related series of drawings appropriate to established photography practice
AS91317 SCr Internal 4 credits

Produce a systematic body of work that shows understanding of art making conventions and ideas within painting
AS91321 SCr External 12 credits

Produce a resolved work that demonstrates control of skills appropriate to cultural conventions
AS91325 Se SCr Internal 4 credits

AR3000

Painting

NCEA Level 3 (course endorsement available)

In Level 3 Painting, students study, develop and produce a body of work. They learn to critically engage, evaluate and investigate artistic procedures and practices. Researching the work of contemporary artists informs the development of their own ideas. Although the emphasis is on painting, student work can demonstrate influences from design, printmaking, sculpture and photography.

New Zealand Scholarship exams are designed to extend very high-achieving Level 3 students. Those who wish to enter the New Zealand Scholarship exam in this subject must discuss this option with their Te Kura subject teacher.

Recommended prior learning: NCEA Level 2 Visual Art course or equivalent.

This course is accessed through our online learning environment – My Te Kura.

Use drawing to demonstrate understanding of conventions appropriate to painting

AS91446 Internal 4 credits

Systematically clarify ideas using drawing informed by established painting practice

AS91451 Internal 4 credits

Produce a systematic body of work that integrates conventions and regenerates ideas within painting practice

AS91456 External 14 credits

AR3100

Printmaking

NCEA Level 3 (course endorsement available)

In Level 3 Printmaking, students study, develop and produce a body of work. They learn to critically engage, evaluate and investigate artistic procedures and practices. Researching the work of contemporary artists informs the development of their own ideas. Although the emphasis is on printmaking, student work can demonstrate influences from design, painting, sculpture and photography.

New Zealand Scholarship exams are designed to extend very high-achieving Level 3 students. Those who wish to enter the New Zealand Scholarship exam in this subject must discuss this option with their Te Kura subject teacher.

Recommended prior learning: NCEA Level 2 Visual Art course or equivalent.

This course is accessed through our online learning environment – My Te Kura.

Use drawing to demonstrate understanding of conventions appropriate to printmaking

AS91448 Internal 4 credits

Systematically clarify ideas using drawing informed by established printmaking practice

AS91453 Internal 4 credits

Produce a systematic body of work that integrates conventions and regenerates ideas within printmaking practice

AS91458 External 14 credits

AR3200

Sculpture

NCEA Level 3 (course endorsement available)

In Level 3 Sculpture, students study, develop and produce a body of work. They learn to critically engage, evaluate and investigate artistic procedures and practices. Researching the work of contemporary artists informs the development of their own ideas. Although the emphasis is on sculpture, student work can demonstrate influences from design, printmaking, photography and painting.

New Zealand Scholarship exams are designed to extend very high-achieving Level 3 students. Those who wish to enter the New Zealand Scholarship exam in this subject must discuss this option with their Te Kura subject teacher.

Recommended prior learning: NCEA Level 2 Visual Art course or equivalent.

This course is accessed through our online learning environment – My Te Kura.

Use drawing to demonstrate understanding of conventions appropriate to sculpture

AS91449 Internal 4 credits

Systematically clarify ideas using drawing informed by established sculpture practice

AS91454 Internal 4 credits

Produce a systematic body of work that integrates conventions and regenerates ideas within sculpture practice

AS91459 External 14 credits

AR3300**Design**

NCEA Level 3 (course endorsement available)

In Level 3 Design, students study, develop and produce a body of work. They learn to critically engage, evaluate and investigate artistic procedures and practices. Researching the work of contemporary artists and designers informs the development of their own ideas. Although the emphasis is on design, student work can demonstrate influences from printmaking, photography, painting and sculpture.

New Zealand Scholarship exams are designed to extend very high-achieving Level 3 students. Those who wish to enter the New Zealand Scholarship exam in this subject must discuss this option with their Te Kura subject teacher.

Recommended prior learning: NCEA Level 2 Design or equivalent study and experience of digital media applications (Photoshop, InDesign). All enquiries regarding equivalency should be directed to the senior teacher of the subject prior to enrolment and registration.

This course is accessed through our online learning environment – My Te Kura.

Use drawing to demonstrate understanding of conventions appropriate to design

AS91445 Internal 4 credits

Systematically clarify ideas using drawing informed by established design practice

AS91450 Internal 4 credits

Produce a systematic body of work that integrates conventions and regenerates ideas within design practice

AS91455 External 14 credits

AR3400**Photography**

NCEA Level 3 (course endorsement available)

In Level 3 Photography, students study, develop and produce a body of work. They learn to critically engage, evaluate and investigate artistic procedures and practices. Researching the work of contemporary artists and designers informs the development of their own ideas. Although the emphasis is on photography, student work can demonstrate influences from printmaking, design, painting and sculpture.

New Zealand Scholarship exams are designed to extend very high-achieving Level 3 students. Those who wish to enter the New Zealand Scholarship exam in this subject must discuss this option with their Te Kura subject teacher.

Recommended prior learning: NCEA Level 2 Photography or equivalent study and experience of digital media applications (Photoshop, InDesign). All enquiries regarding equivalency should be directed to the senior teacher of the subject prior to enrolment and registration.

This course is accessed through our online learning environment – My Te Kura.

Use drawing to demonstrate understanding of conventions appropriate to photography

AS91447 Internal 4 credits

Systematically clarify ideas using drawing informed by established photography practice

AS91452 Internal 4 credits

Produce a systematic body of work that integrates conventions and regenerates ideas within photography practice

AS91457 External 14 credits

Art History

Te Toi Hitori

Students who have an interest in art can learn how and why it has been produced. This involves the observation, analysis and interpretation of works of art within their cultural and historical contexts. Students develop the analytical, critical and research skills needed to gain a greater understanding of artistic ideas and concepts. This subject does not require any practical skills in art.

AH2000

Art History

NCEA Level 2 (course endorsement available)

Towards modernism (nineteenth century French art) and art in Aotearoa are used as starting points for students to develop the art historical skills of observation, analysis and understanding of content and context.

Recommended prior learning: A reasonable level of literacy is required.

This course is accessed through our online learning environment – My Te Kura.

Examine the effects of formal elements of art works

AS91180 (la) UElwa SCr External 4 credits

Examine the meanings conveyed by art works

AS91181 (la) UElwa Se SCr External 4 credits

Examine the influence of context(s) on art works

AS91182 (la) UElwa SCr External 4 credits

Examine how media are used to create effects in art works

AS91183 (la) Se SCr Internal 4 credits

Communicate understanding of an art history topic

AS91184 (la) UElra SCr Internal 4 credits

Communicate a considered personal response to art works

AS91185 (la) SCr Internal 4 credits

Demonstrate understanding of art works in relation to their physical environments

AS91186 (la) Se SCr Internal 4 credits

AH3000

Art History

NCEA Level 3 (course endorsement available)

The focus of this course is Renaissance art, a period that helped shape the history of art. Students learn to analyse and interpret art within a cultural and historical context. The option offered is Late Renaissance to Mannerism.

This course is recommended to students with an interest in the arts, English, history or classical studies. It is also useful for students considering further tertiary study in any of these areas. It is not necessary to have studied Art History at Level 2.

New Zealand Scholarship exams are designed to extend very high-achieving Level 3 students. Those who wish to enter the New Zealand Scholarship exam in this subject must discuss this option with their Te Kura subject teacher.

Recommended prior learning: A good level of literacy is required.

This course is accessed through our online learning environment – My Te Kura.

Demonstrate understanding of style in art works

AS91482 (la) UElwra External 4 credits

Examine how meanings are communicated through art works

AS91483 (la) UElwra External 4 credits

Examine the relationship(s) between art and context

AS91484 (la) UElwra External 4 credits

Examine the impact of media and processes on art works

AS91485 (la) UElra Internal 4 credits

Construct an argument based on interpretation of research in art history

AS91486 (la) UElra Internal 4 credits

Examine the different values placed on art works

AS91487 (la) UElra Internal 4 credits

Examine the relationship(s) between a theory and art works

AS91488 (la) UEIra Internal 4 credits

Analyse texts about art

AS91489 (la) UEIra Internal 4 credits

Biology

Te Mātauranga Koiora

Biology is at the centre of all life and students explore the living world, its ecology, plant and animal life processes, evolution, and relationships between biology and technology. Through this study, students gain an understanding of themselves, the world, and how organisms survive and live together. They also develop essential scientific knowledge, methods and techniques. From here, students are able to analyse scientific information effectively and discuss the wide range of implications science has on our world, including medical and environmental issues. Biology is a broad interest subject and is important for careers and in a variety of areas, from health through to forestry and zoology.

BY1000

Biology

NCEA Level 1 (course endorsement available)

This course provides an introduction to the living world, its ecology, and human organ systems. It offers a range of science and biology standards.

Students wishing to continue with their biological studies at NCEA Level 2 and beyond are advised to prepare for at least one Science external (AS90948) and one externally assessed Biology standard (AS90928 or AS90929).

Recommended prior learning: Students should have a reasonable level of literacy.

This course is accessed through our online learning environment – My Te Kura.

Carry out a practical investigation in a biological context, with direction

AS90925 (na) UEna Ma Pr Se So Internal 4 credits

Report on a biological issue

AS90926 (la) Pr Internal 3 credits

Demonstrate understanding of biological ideas relating to the life cycle of flowering plants

AS90928 (la) Pr External 4 credits

Demonstrate understanding of biological ideas relating to a mammal(s) as a consumer(s)

AS90929 (la) Pr Se So External 3 credits

Demonstrate understanding of biological ideas relating to genetic variation

AS90948 (la) Ma Pr So Cr External 4 credits

Investigate life processes and environmental factors that affect them

AS90949 Pr Se So Cr Internal 4 credits

Investigate biological ideas relating to interactions between humans and micro-organisms

AS90950 Co Ma Pr Se So Cr Internal 4 credits

Investigate the biological impact of an event on a New Zealand ecosystem

AS90951 Pr Se Cr Internal 4 credits

BY2000

Biology

NCEA Level 2 (course endorsement available)

This NCEA Level 2 course offers students the opportunity to explore topics such as ecology, genetics and gene expression. Alongside these topics, students study cell structure and processes and gain skills to analyse the increasing complexity of biological information that is presented to the public. They will also be able to carry out a practical investigation.

Not only is this course highly relevant, it is essential preparation for both the Level 3 Biology course and for students intending to enter tertiary studies in nursing, medicine, veterinary or similar fields.

To be able to successfully start Level 3 Biology, students should have studied AS91156, AS91159 and, if they want to carry out the Level 3 Biology practical investigation, they will need to complete AS91153.

Recommended prior learning: Students should have a reasonable level of literacy and have successfully studied at least AS90948 and AS90949 from Level 1 Science/Biology.

This course is accessed through our online learning environment – My Te Kura.

Carry out a practical investigation in a biology context, with supervision

AS91153 (na) UEna Ma Pr Se So Internal 4 credits

Analyse the biological validity of information presented to the public

AS91154 (la) Pr So Internal 3 credits

Demonstrate understanding of adaptation of plants or animals to their way of life

AS91155 (la) Pr Se So Internal 3 credits

Demonstrate understanding of life processes at the cellular level

AS91156 (la) Pr So External 4 credits

Demonstrate understanding of genetic variation and change

AS91157 (la) Pr So External 4 credits

Investigate a pattern in an ecological community, with supervision

AS91158 (la) Pr Internal 4 credits

Demonstrate understanding of gene expression

AS91159 (la) Pr So External 4 credits

Investigate biological material at the microscopic level

AS91160 Internal 3 credits

BY3000

Biology

NCEA Level 3 (course endorsement available)

This course follows on from Level 2 Biology. In this course, students study plant responses and animal behaviour, biotechnology, evolution, and speciation. Students also have the opportunity to further develop their investigative and research skills.

As well as being highly relevant, this course is useful, and often essential, for students intending to enter tertiary studies in nursing, medicine, veterinary science or similar fields.

University Entrance requires 14 credits in three approved Level 3 subjects, which includes Biology. This means Biology students should sit at least one, preferably two, externally assessed standards.

If students intend to complete AS91601, they should do this in term one or two of the school year.

Recommended prior learning: Students should have a good level of literacy. They also need to have done AS91156 and AS91159 from Level 2 Biology before heading into this course.

Students intending to complete the practical investigation, AS91601, should know how to apply the scientific method when planning and carrying out this investigation.

This course is accessed through our online learning environment – My Te Kura.

Carry out a practical investigation in a biological context, with guidance

AS91601 (lna) UEna Internal 4 credits

Integrate biological knowledge to develop an informed response to a socio-scientific issue

AS91602 (la) UElwra Internal 3 credits

Demonstrate understanding of the responses of plants and animals to their external environment

AS91603 (la) UElwra External 5 credits

Demonstrate understanding of how an animal maintains a stable internal environment

AS91604 (la) UElra Internal 3 credits

Demonstrate understanding of evolutionary processes leading to speciation

AS91605 (la) UElwra External 4 credits

Demonstrate understanding of trends in human evolution

AS91606 (la) UElwra External 4 credits

Demonstrate understanding of human manipulations of genetic transfer and its biological implications

AS91607 (la) UElra Internal 3 credits

Business Studies

Ngā Akoranga Umanga

In a rapidly changing world, it is important that people are able to make informed and rational decisions about business matters. Business Studies considers how individuals and groups organise, plan and act to produce goods and services to satisfy customers. The knowledge and skills gained in Business Studies and exposure to enterprise culture can help shape creative, energetic and enterprising people who will contribute to New Zealand's economic future. In Business Studies, students develop their understanding of business theory and practices in a range of relevant contexts.

BS1000

Business Studies

NCEA Level 1 (course endorsement available)

In this course, students explore the five key themes (business formation, functions of business, people in business, business management and the business environment) within the context of a small-to-medium business, of local, national or international significance. The business should also be connected to their life, for example: a local farm, tourist operator, retail outlet, franchise, or early childcare centre.

Students will look at the internal and external features of businesses that influence their success. They investigate operational business problems and provide causes, impacts, possible solutions and recommendations to address them.

Also studied in this course is the marketing mix model and human resources processes. Students gain knowledge of enterprising behaviour, innovation and entrepreneurship in business contexts.

Recommended prior learning: Students should have a reasonable level of literacy.

This course is accessed through our online learning environment – My Te Kura.

Demonstrate knowledge of innovation and entrepreneurship in business contexts

US22847 Cr Internal 2 credits

Demonstrate an understanding of internal features of a small business

AS90837 (la) Pr Se Cr External 4 credits

Demonstrate an understanding of external factors influencing a small business

AS90838 (la) Pr Se Cr External 4 credits

Apply business knowledge to an operational problem(s) in a given small business context

AS90839 (la) Pr Cr External 4 credits

Apply the marketing mix to a new or existing product

AS90840 (la) Pr Se Cr Internal 3 credits

Investigate aspects of human resource processes in a business

AS90841 (la) Pr Cr Internal 3 credits

BS2000

Business Studies

NCEA Level 2 (course endorsement available)

In this course, students explore the five key themes (business formation, functions of business, people in business, business management and the business environment) within the context of a medium-to-large business of local, national or international significance. The business should also be connected to their life, for example: a listed company, a retail company with multiple outlets, a school, local government, a large corporation, or a bank.

Students look at internal and external features, critical business problems, and apply business knowledge to provide possible solutions and recommendations to address them. They also have the opportunity to conduct market research and identify motivation practices and apply their knowledge of motivation theory in a business.

Recommended prior learning: Students should have a reasonable level of literacy.

This course is accessed through our online learning environment – My Te Kura.

Demonstrate and apply knowledge of office equipment and administration processes

US121 SSe Cr Internal 5 credits

Demonstrate understanding of the internal operations of a large business

AS90843 (la) Pr Se Cr External 4 credits

Demonstrate understanding of how a large business responds to external factors

AS90844 (la) Pr Se Cr External 4 credits

Apply business knowledge to a critical problem(s) in a given large business context

AS90845 (la) Pr Cr External 4 credits

Conduct market research for a new or existing product

AS90846 (lna) UEna Pr Se Cr Internal 3 credits

Investigate the application of motivation theory in a business

AS90847 (la) Se Cr Internal 3 credits

Chemistry

Te Māturanga Matū

People have always been fascinated by the world around us and chemistry is the study of the substances that make up the universe. From the time people worked out how to create fire, chemistry has been at the forefront of exciting discoveries such as the structure of DNA and the use of semiconductors in electronics. Chemistry looks at the behaviour of substances, the changes they undergo to create new ones and the reactions between them. Yet it is more than what happens at a micro level, it is about what it is that makes us, our materials and everything around us. Students learn the essential skills and knowledge needed to analyse scientific information, conduct experiments and research. Chemistry is essential for careers in a wide range of areas including medicine, pharmacy, engineering, environmental science, wine making and food technology.

CH1000

Chemistry

NCEA Level 1 (course endorsement available)

This course provides an introduction to the basics of chemistry. Students should enrol for this course if they wish to focus on studying the material world and intend to sit at least one externally assessed examination paper.

Students wishing to continue with Level 2 Chemistry should complete at least AS90944: Demonstrate understanding of aspects of acids and bases. Students are expected to complete five of the standards listed below.

Recommended prior learning: Students should have a reasonable level of literacy.

This course is accessed through our online learning environment – My Te Kura.

Carry out a practical chemistry investigation, with direction

AS90930 (na) UEna Co Ma Pr Se Cr Internal 4 credits

Demonstrate understanding of the chemistry in a technological application

AS90931 (la) Co Ma Pr Se Cr Internal 2 credits

Demonstrate understanding of aspects of chemical reactions

AS90934 External 4 credits

Demonstrate understanding of aspects of acids and bases

AS90944 Co Ma Pr Cr External 4 credits

Investigate implications of the use of carbon compounds as fuels

AS90945 Co Ma Pr Se So Cr Internal 4 credits

Investigate the implications of the properties of metals for their use in society

AS90946 Co Ma Pr Cr Internal 4 credits

Investigate selected chemical reactions

AS90947 Co Ma Pr So Cr Internal 4 credits

CH2000

Chemistry

NCEA Level 2 (course endorsement available)

This course further develops some of the chemistry topics introduced in Level 1 Science, and investigates general scientific nature and problems, oxidation and reduction, and the various reactions that chemical substances undergo. The use of formulae and equations and the application of mathematics to these are a very important part of the course. Practical work is part of this course, much of which can be done at home.

Note: AS91161 requires access to a school or industrial laboratory. AS91163 requires a good understanding of Level 2 Chemistry and so is normally attempted last.

Recommended prior learning: AS90944 or equivalent.

This is an online course available through our online learning environment – My Te Kura

Analyse oxidation – reduction reactions

US6345 Internal 4 credits

Carry out quantitative analysis

AS91161 (na) UEna Co Ma Pr So Cr Internal 4 credits

Carry out procedures to identify ions present in solution

AS91162 Internal 3 credits

Demonstrate understanding of the chemistry used in the development of a current technology

AS91163 (la) Co Ma Pr Se So Cr Internal 3 credits

Demonstrate understanding of bonding, structure, properties and energy changes

AS91164 (la) Co Ma Pr So Cr External 5 credits

Demonstrate understanding of the properties of selected organic compounds

AS91165 (la) Co Ma Pr Se So Cr External 4 credits

Demonstrate understanding of chemical reactivity

AS91166 (1a) Co Ma Pr Se So Cr External 4 credits

Demonstrate understanding of oxidation-reduction

AS91167 Co Ma Pr So Cr Internal 3 credits

CH3000

Chemistry

NCEA Level 3 (course endorsement available)

This course takes a deeper look at what helps create our world, and takes the concepts discussed in Level 2 to a more advanced level. There is a focus on the role of energy and using particles at the microscopic level to explain the properties observed at the macroscopic level.

Topics introduced include electronic structures and spontaneity of reactions including electrochemical processes. Spectroscopic analysis of organic compounds is also investigated. Since quantitative analysis is involved with chemistry, confidence in general mathematics, simple algebra and graphs is useful and the course is aimed at students going on to tertiary studies in chemistry.

Note: AS91389: Demonstrate understanding of chemical processes in the world around us requires a good understanding of Level 3 Chemistry and so should be completed near the end of the course.

Recommended prior learning: Five standards completed at NCEA Level 2 Chemistry or equivalent.

This course is accessed through our online learning environment – My Te Kura.

Analyse oxidation-reduction reactions

US6345 Internal 4 credits

Characterise the composition of acid and base solutions

US8949 Internal 4 credits

Demonstrate understanding of spectroscopic data in chemistry

AS91388 Internal 3 credits

Demonstrate understanding of chemical processes in the world around us

AS91389 (1a) UElwra Internal 3 credits

Demonstrate understanding of thermochemical principles and the properties of particles and substances

AS91390 (1a) External 5 credits

Demonstrate understanding of the properties of organic compounds

AS91391 (1a) External 5 credits

Demonstrate understanding of equilibrium principles in aqueous systems

AS91392 (1na) UEna External 5 credits

Demonstrate understanding of oxidation-reduction processes

AS91393 (1a) Internal 3 credits

Chinese

Te Reo Hainamana

Chinese is not only one of the oldest living languages, but it is also a major world language spoken across the globe by over one billion people. As the New Zealand population diversifies, Chinese is becoming a major language in this country while remaining highly important for trade and tourism. For some students, the history and very look of its written characters are fascinating, while for others it is a chance to stay in touch with their own family background. This subject focuses on both spoken and written modern standard Chinese (Mandarin), which is used throughout China, Singapore and Taiwan. It also explores the culture of Chinese-speaking countries.

ZH000

Beginners' Chinese

Curriculum Level 1–5

This is a beginners' course in modern standard Chinese (Mandarin). Students practise everyday listening and speaking skills, reading and writing the Pinyin alphabetical system and some simple characters.

They learn simple greetings, how to introduce themselves and family members, how to say numbers, time and age, their likes and dislikes, school, daily routine, shopping and food. They also learn about life and customs in China.

The course can be taken over one or two years. We recommend students who want to do NCEA Level 1 should complete this course first.

Recommended prior learning: No prior learning needed.

This course is accessed through our online learning environment – My Te Kura.

Students will be required to make and submit audio and/or video recordings, so a microphone and camera or mobile device are required.

ZH1000

Chinese

NCEA Level 1 (course endorsement available)

This course builds on language already covered in Beginners' Chinese (ZH000). Students are required to translate, listen and engage with the language as much as possible. Students develop their listening and speaking skills in modern standard Chinese (Mandarin) and their reading and writing of simplified characters. They also learn using Pinyin as a means of expanding their range of language. By the end of this course, students are able to read and recognise around 370 characters and write 220 characters.

Students will also be able to communicate the time, direction, seasons and their daily routine. The Chinese language and its relationship with life and customs in China is highlighted, with topics including folk stories and legends, sport, food and festivals.

Recommended prior learning: Students must have completed Year 10 Chinese or equivalent or have a Chinese language background. Ability to read and write about 100 Chinese characters is essential.

This course is accessed through our online learning environment – My Te Kura.

Students will be required to make and submit audio and/or video recordings, so a microphone and camera or mobile device are required.

Demonstrate understanding of a variety of spoken Chinese texts on areas of most immediate relevance

AS90868 Pr Se So Cr External 5 credits

Give a spoken presentation in Chinese that communicates a personal response

AS90869 Pr Internal 4 credits

Demonstrate understanding of a variety of Chinese texts on areas of most immediate relevance

AS90871 Se External 5 credits

Write a variety of text types in Chinese on areas of most immediate relevance

AS90872 Se Cr Internal 5 credits

ZH2000**Chinese**

NCEA Level 2 (course endorsement available)

This course builds on language already mastered in Level 1. Students continue to develop general listening and speaking skills and expand their ability to read and write simplified characters. Over the year, students learn how to communicate information about themselves and their friends, their home country and future plans, as well as how to write a CV. As with previous courses, a focus on Chinese culture is emphasised, and issues surrounding living in a foreign country and their customs and behaviour are covered.

Recommended prior learning: NCEA Level 1 Chinese or equivalent.

This course is accessed through our online learning environment – My Te Kura.

Students will be required to make and submit audio and/or video recordings, so a microphone and camera or mobile device are required.

Demonstrate understanding of a variety of spoken Chinese texts on familiar matters

AS91108 Se Cr External 5 credits

Interact using spoken Chinese to share information and justify ideas and opinions in different situations

AS91109 SSe So Cr Internal 5 credits

Give a spoken presentation in Chinese that communicates information, ideas and opinions

AS91110 Internal 4 credits

Demonstrate understanding of a variety of written and/or visual Chinese text(s) on familiar matters

AS91111 Se External 5 credits

Write a variety of text types in Chinese to convey information, ideas, and opinions in genuine contexts

AS91112 Se Cr Internal 5 credits

ZH3000**Chinese**

NCEA Level 3 (course endorsement available)

This course develops students' ability to communicate in Chinese in a variety of situations. Throughout the course, opportunities are provided to listen to and speak Chinese, as well as to read and write using simplified characters to an advanced level. Students learn not only how to express a point of view, but also how to support an argument or provide suggestions. Chinese culture is also considered, in particular the matter of cultural differences, and the skills and advice required to plan a trip to China are covered.

New Zealand Scholarship exams are designed to extend very high-achieving Level 3 students. Those who wish to enter the New Zealand Scholarship exam in this subject must discuss this option with their Te Kura subject teacher.

Recommended prior learning: NCEA Level 2 Chinese or equivalent.

This course is accessed through our online learning environment – My Te Kura. It includes a mix of interactive online modules and downloadable resources in PDF format.

Students will be required to make and submit audio and/or video recordings, so a microphone and camera or mobile device are required.

Demonstrate understanding of a variety of extended spoken Chinese texts

AS91533 External 5 credits

Give a clear spoken presentation in Chinese that communicates a critical response to stimulus material

AS91534 Internal 3 credits

Interact clearly using spoken Chinese to explore and justify varied ideas and perspectives in different situations

AS91535 Internal 6 credits

Demonstrate understanding of a variety of extended written and/or visual Chinese texts

AS91536 External 5 credits

Write a variety of text types in clear Chinese to explore and justify varied ideas and perspectives

AS91537 Internal 5 credits

Classics and Religious Studies

Te Akoranga Puāwaitanga me ngā Hāhi

Many of Western culture's roots can be traced back to Ancient Greece and Rome. Classical Studies looks into the lives, beliefs and creations of the people of these civilisations. Not only has much of our literature, language, art and architecture been developed from the classical world, but its influence can be seen in science, mathematics, laws and systems of government as well. By comparing our modern ways of living with these origins, we can gain a greater understanding of the current world and its influences. Classical Studies is a multi-disciplinary subject, which covers topics including politics, religion and philosophy. Students gain a wide range of historical knowledge and cultural insight while developing their analytical, critical and research skills.

GL2000

Classical Studies

NCEA Level 2 (course endorsement available)

This course is an introduction to the classical world, where students learn about Ancient Greek and Roman art, beliefs and literature. This includes a study of classical mythology, Homer's epic poem 'The Odyssey' and Greek tragedy. The golden age of Greece is foreshadowed in a study of the Persian Wars. The change from the Republic to the Empire in Rome is studied in 'The Death of Caesar'.

There are also 18 credits of Religious Studies assessments available. Religious Studies is an approved University Entrance subject. It is research-based and all material is available on the internet. Contact your teacher for further information.

Recommended prior learning: Students should have a good level of literacy.

This course is accessed through our online learning environment – My Te Kura.

Examine ideas and values of the classical world

AS91200 (la) UElwra SCr External 4 credits

Examine the significance of features of work(s) of art in the classical world

AS91201 (la) UElwra Se SCr External 4 credits

Demonstrate understanding of a significant event in the classical world

AS91202 (la) UElra SCr Internal 4 credits

Examine socio-political life in the classical world

AS91203 (la) UElwra SCr External 6 credits

Demonstrate understanding of the relationship between aspects of the classical world and aspects of other cultures

AS91204 (la) UElra SCr Internal 6 credits

GL3000

Classics and Religious Studies

NCEA Level 3 (course endorsement available)

Theatre and literature and their relation to life in Ancient Greece and Rome form a large part of this course. Importantly, these still influence us today, with much Western drama and fiction originating from this time. Students will encounter the Greek Attic comedy of Aristophanes, as well as Virgil's epic poem 'The Aeneid'.

In turn, an introduction to the concepts behind Greek vase painting and a historical study of Alexander the Great is also offered.

Throughout the course, students gain further insight into not just ancient culture but the way we act, think and live today. There are also 18 credits of Religious Studies assessments available.

Recommended prior learning: Students should have a very good level of literacy.

This course is accessed through our online learning environment – My Te Kura.

Analyse ideas and values of the classical world

AS91394 (la) UElwra External 4 credits

Analyse the significance of a work(s) of art in the classical world

AS91395 (la) UElwra External 4 credits

Analyse the impact of a significant historical figure on the classical world

AS91396 (la) UElwra External 6 credits

Demonstrate understanding of significant ideology(ies) in the classical world

AS91397 (la) UElra Internal 6 credits

Demonstrate understanding of the lasting influences of the classical world on other cultures across time

AS91398 (la) UElra Internal 6 credits

Religious Studies

Religious Studies is an approved University Entrance subject. It is research-based and all material is available on the internet. Contact your teacher for further information.

Note: Religious Studies and Classical Studies are from separate domains (subject areas) for UE approved subjects – i.e. the credits for Classics and Religious Studies cannot be combined. However, all credits gained do count towards NCEA Level 3.

Analyse the response of a religious tradition to a contemporary ethical issue

AS90826 (la) UEIra Internal 6 credits

Analyse the key beliefs of a religious tradition and a secular world view in relation to ultimate questions

AS90827 (la) UEIra Internal 6 credits

Analyse the meanings in a sacred text within a religious tradition

AS91725 (la) UEIra Internal 6 credits

Commerce Studies

Te Mātauranga Tauhokohoko

Commerce Studies students learn about specialist commerce subjects by choosing from a broad range of topics that match their interests and passions. Students select topics from Accounting, Business Studies, Economics and/or Legal Studies. If students enjoy a particular subject, this can take them to further study of their chosen specialist subject.

CMI000

Commerce Studies

NCEA Level 1 (course endorsement not available)

This course offers a range of topics from Level 1 Accounting, Economics, Business Studies and Legal Studies. It is designed for students who are unable to sit external exams due to particular circumstances. It offers internally assessed standards only and students are recommended to select approximately 18–20 credits.

Note that this course does not offer course endorsement as students will not have the opportunity to sit external exams.

Recommended prior learning: Students should have a reasonable level of literacy.

This course is accessed through our online learning environment – My Te Kura.

Describe basic employment rights and responsibilities, and sources of information and/or assistance

US1978 Pr So Internal 3 credits

Demonstrate knowledge of accessing legal assistance

US8548 Pr So Cr Internal 2 credits

Demonstrate knowledge of innovation and entrepreneurship in business contexts

US22847 Cr Internal 2 credits

Apply the marketing mix to a new or existing product

AS90840 (la) Pr Se Cr Internal 3 credits

Investigate aspects of human resource processes in a business

AS90841 (la) Pr Cr Internal 3 credits

Prepare financial information for a community organisation's annual general meeting

AS90979 (la) Se Cr Internal 4 credits

Make a financial decision for an individual or group

AS90981 (la) Se Cr Internal 3 credits

Demonstrate understanding of cash management for a small entity

AS90982 (la) Se Cr Internal 4 credits

Demonstrate understanding of decisions a producer makes about production

AS90984 (la) Pr Se Cr Internal 5 credits

Demonstrate understanding of a government choice where affected groups have different viewpoints

AS90987 (la) Pr Se Cr Internal 4 credits

Demonstrate understanding of the interdependence of sectors of the New Zealand economy

AS90988 (la) Pr Se So Cr Internal 3 credits

CM2000

Commerce Studies

NCEA Level 2 (course endorsement not available)

This course offers a range of topics from Level 2 Accounting, Economics, Business Studies and Legal Studies. It is designed for students who are unable to sit external exams due to particular circumstances. It offers internally assessed standards only and students are recommended to select approximately 18–20 credits.

Note that this course does not offer course endorsement as students will not have the opportunity to sit external exams. If students wish to progress to Level 3 Accounting, further learning may be required.

Recommended prior learning: Students should have a reasonable level of literacy.

This course is accessed through our online learning environment – My Te Kura.

Demonstrate and apply knowledge of office equipment and administration processes

US121 SSe Cr Internal 5 credits

Describe factors contributing to, and consequences of, crime

US8545 Sc Internal 3 credits

Describe the objectives and application of consumer law

US8555 Cr Sc Internal 3 credits

Describe the legal rights and personal responsibilities of secondary school students

US10337 Sc Internal 3 credits

Conduct market research for a new or existing product

AS90846 (Ina) UEna Pr Se Cr Internal 3 credits

Investigate the application of motivation theory in a business

AS90847 (Ia) Se Cr Internal 3 credits

Demonstrate understanding of accounting processing using accounting software

AS91175 (na) UEna Se Cr Internal 4 credits

Demonstrate understanding of an accounts receivable subsystem for an entity

AS91179 (Ina) UEna Cr Internal 3 credits

Analyse unemployment using economic concepts and models

AS91225 (Ia) Cr Internal 4 credits

Analyse statistical data relating to two contemporary economic issues

AS91226 (Ina) UEna Se Cr Internal 4 credits

Demonstrate understanding of an inventory subsystem for an entity

AS91386 (Ina) Uena SSe Internal 3 credits

Demonstrate understanding of a contemporary accounting issue for decision-making

AS91481 (Ia) Cr Internal 4 credits

Design and Visual Communication

Ngā mahi hoahoa me te Whakawhitiwhiti ataata

Design and Visual Communication, also known as Graphics, is for students interested in design and drawing. Students develop visual communication skills and design thinking to explore and solve design problems. Students develop skills in sketching, rendering, drawing and modelling to explore, communicate and present their ideas. In some topics, students are able to have models of their design work 3D printed by Te Kura. Students are encouraged to generate creative and innovative solutions to solve design problems that are set in authentic contexts, and can be customised to suit their interests.

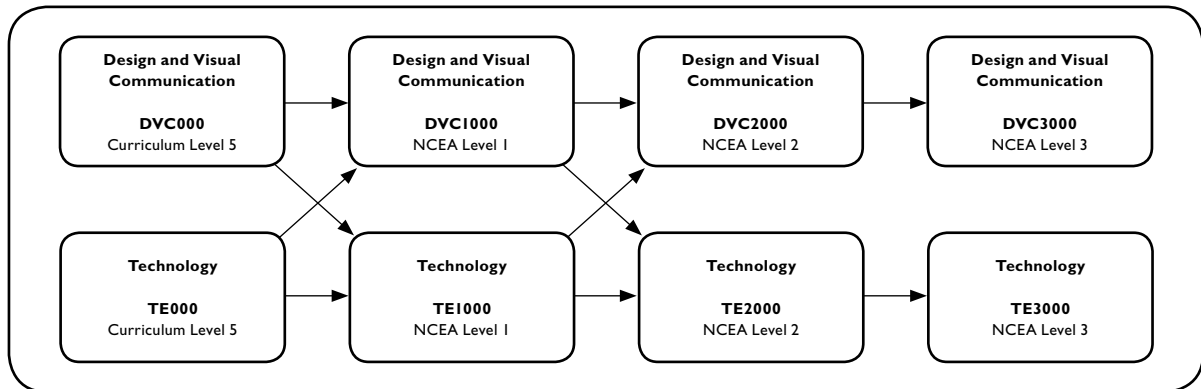

DVC000

Design and Visual Communication

Curriculum Level 5

This introductory course will appeal to any student who enjoys sketching and is interested in the challenge of solving design problems. Students learn design and drawing techniques, which enables them to design everyday objects and present them visually, including having a model 3D printed. Students will include influences from their cultural and physical contexts in their design projects. Topics include product and spatial design, sketching, rendering, modelling and instrumental drawing.

Recommended prior learning: No prior learning needed.

This course is accessed through our online learning environment – My Te Kura.

An optional topic develops presentation techniques. The work done in these projects contributes to internally assessed standards and a portfolio for external assessment.

Recommended prior learning: No prior learning needed.

This course is accessed through our online learning environment – My Te Kura.

Produce freehand sketches that communicate design ideas

AS91063 Co Ma Cr External 3 credits

Produce instrumental, multi-view orthographic drawings that communicate technical features of design ideas

AS91064 (na) UEna Co Ma Cr External 3 credits

Produce instrumental paraline drawings to communicate design ideas

AS91065 (na) UEna Co Ma Cr External 3 credits

Use rendering techniques to communicate the form of design ideas

AS91066 Co Ma Cr Internal 3 credits

Use the work of an influential designer to inform design ideas

AS91067 Ma Cr Internal 3 credits

Undertake development of design ideas through graphics practice

AS91068 Co Ma Cr Internal 6 credits

DVC1000

Design and Visual Communication

NCEA Level 1 (course endorsement available)

This course develops students' visual communication and design skills. Students start the course exploring the influence of a significant designer and then move on to two major design projects, within the contexts of product design and spatial design. The design briefs are customisable to reflect individual student's interests and passions. Interspersed in the projects are exercises to develop students' technical skills.

Promote an organised body of design work to an audience using visual communication techniques

AS91069 (la) Co Ma Cr Internal 4 credits

DVC2000

Design and Visual Communication

NCEA Level 2 (course endorsement available)

This course develops students' design capabilities. Initially students explore a design movement of their choice and then embed its influence into their own conceptual design. They then explore practices specific to product and spatial designers through two major design projects, which are customised to reflect their personal interests.

Students are challenged to examine solutions to design problems in greater depth. Interspersed in the projects are exercises to advance students' technical skills. The work done in these projects contributes to internally assessed standards and a portfolio for external assessment.

Design-focused students can complete an optional topic creating a presentation of one of their projects. Technically oriented students can complete a set of working drawings for one of their projects.

Recommended prior learning: NCEA Level 1 Design and Visual Communication or equivalent.

This course is accessed through our online learning environment – My Te Kura.

Use visual communication techniques to generate design ideas

AS91337 SCo Ma Pr Se SCr External 3 credits

Produce working drawings to communicate technical details of a design

AS91338 Ci Cr Mt Pi External 4 credits

Use the characteristics of a design movement or era to inform own design ideas

AS91340 SCr Internal 3 credits

Develop a spatial design through graphics practice

AS91341 (la) SCo Ma SCr Internal 6 credits

Develop a product design through graphics practice

AS91342 SCo SMa SCr Internal 6 credits

Use visual communication techniques to compose a presentation of a design

AS91343 SCo Ma Se SCr Internal 4 credits

DVC3000

Design and Visual Communication

NCEA Level 3 (course endorsement available)

This online course covers NCEA Level 3 and Scholarship. Students develop their own design briefs, which are based on authentic situations in the contexts of spatial and product design. They are challenged to generate innovative and creative design ideas and carry them through to highly resolved design solutions.

During this process they participate in online discussions and critiques, submitting their work digitally. Students work in a range of different media, both paper based and digital, and can have some models 3D printed by Te Kura. Final assessments are paper based and submitted by post. Access to a digital camera or scanner is essential.

Recommended prior learning: NCEA Level 2 Design and Visual Communication or equivalent.

This course is accessed through our online learning environment – My Te Kura.

Initiate design ideas through exploration

AS91627 External 4 credits

Develop a visual presentation that exhibits a design outcome to an audience

AS91628 Internal 6 credits

Resolve a spatial design through graphics practice

AS91629 Internal 6 credits

Resolve a product design through graphics practice

AS91630 Internal 6 credits

Digital Technology

Te Hangarau Mamatai

Digital Technology students learn to effectively find, create, communicate and use information in a digital context. Students are also provided with an excellent introduction to the world of information communication technology.

These courses are being redesigned to meet the new Digital Technology Curriculum. During 2019 there may be changes as exciting new modules are introduced and old ones phased out. You will be informed of changes well in advance and your teacher will discuss these with you.

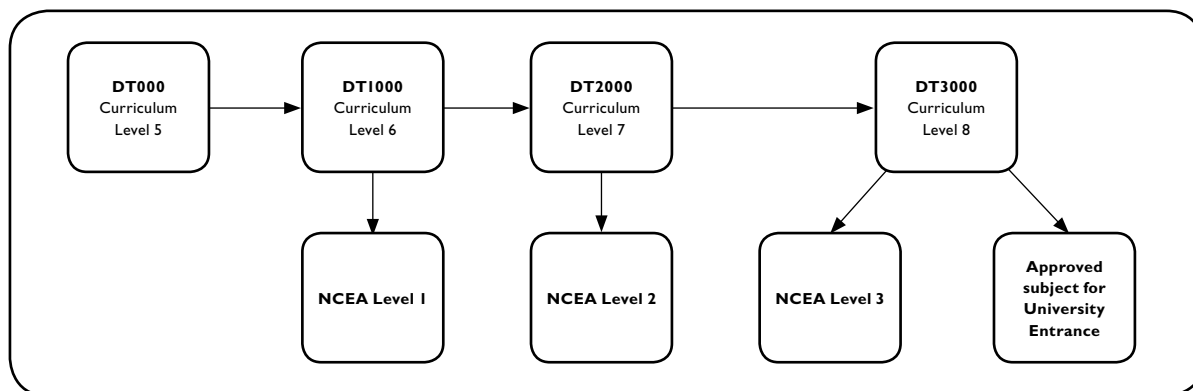

DT000

Digital Technology

Curriculum Level 5

This course offers a wide range of different digital learning experiences which will appeal to all students. Activities are exciting and are based on student interest. There is a creative focus and students are guided to participate in a digital environment that they are responsible for creating. Students are introduced to web design, coding and programming, design, digital imaging, computer science, cyber safety and how to become better digital citizens.

Recommended prior learning: No prior learning needed.

This course is accessed through our online learning environment – My Te Kura.

DT1000

Digital Technology

NCEA Level 1 (course endorsement available)

This Level 1 online course offers students the opportunity to explore topics such as programming, web design and photo editing, desktop publishing, word processing and spreadsheets. The course offers topics that can be studied in any order.

Recommended prior learning: DT000 modules recommended.

This course is accessed through our online learning environment – My Te Kura.

Develop and use keyboarding skills to enter text

US101 Pr So Internal 3 credits

Consolidate keyboarding skills and produce accurate text based documents

US102 Pr So Internal 3 credits

Demonstrate and apply knowledge of a personal computer system

US2780 Pr Cr Internal 3 credits

Manage and protect data in a personal computer

US2781 Co Ma So Cr Internal 3 credits

Produce simple desktop published documents using templates

US2792 Ma Pr Cr Internal 2 credits

Use computer technology to create and deliver a presentation from given content

US5946 Ma Cr Internal 3 credits

Demonstrate an understanding of ergonomic principles for computer workstations

US6743 Ma Cr Internal 2 credits

Enter and manage text for generic text and information management

US12883 Pr So Internal 4 credits

Produce a spreadsheet from instructions using supplied data

US18743 Ma Pr So Cr Internal 2 credits

Produce still images for a range of digital media

US26745 Ma Cr Internal 3 credits

DT2000

Digital Technology

NCEA Level 2 (course endorsement available)

This online Level 2 course offers students the opportunity to further explore programming, web design and other topics studied in Digital Technology NCEA Level 1 (DT1000). The topics can be studied in any order.

Recommended prior learning: DT1000 modules recommended.

This course is accessed through our online learning environment – My Te Kura.

Use a word processor to produce documents for a business or organisation

US111 Se So Internal 5 credits

Manage and protect data in a personal computer

US2781 Co Ma So Cr Internal 3 credits

Create and use a computer spreadsheet to solve a problem

US2784 Co Ma Pr Se So Cr Internal 3 credits

Produce desktop published documents to meet a set brief

US2788 Co Ma SCr Internal 5 credits

Integrate spreadsheet and database data into word processed documents to meet a set brief

US2791 Co Ma Pr Cr Internal 3 credits

Produce a presentation using a desktop presentation computer application

US5940 Co Ma SCr Internal 3 credits

Demonstrate an understanding of ergonomic principles for computer workstations

US6743 Ma Cr Internal 2 credits

Create a website using a mark-up language to meet a set brief

US25656 Ma SCr Internal 3 credits

Demonstrate understanding of advanced concepts relating to managing shared information within information systems

AS91367 (1a) SMa Pr Se Cr External 3 credits

Implement advanced procedures to produce a specified digital media outcome

AS91370 SMa Se SCr Internal 4 credits

Demonstrate understanding of advanced concepts from computer science

AS91371 (1a) SMa SCr External 4 credits

Construct a plan for an advanced computer program for a specified task

AS91372 Internal 3 credits

Construct an advanced computer program for a specified task

AS91373 SMa SCr Internal 3 credits

Demonstrate understanding of local area network technologies

AS91377 (1a) SMa Cr Internal 3 credits

DT3000

Digital Technology

NCEA Level 3 (course endorsement available)

This is an online Level 3 course and an approved University Entrance (UE) subject. Students can explore topics such as databases, desktop publishing, web design and spreadsheets. It is recommended that students aiming for UE complete the topics where achievement standards are being offered.

Recommended prior learning: DT2000 modules recommended.

This course is accessed through our online learning environment – My Te Kura.

Create a computer spreadsheet to provide a solution for organisation use

US2785 Internal 5 credits

Create and use a computer database to provide a solution for organisation use

US2787 Internal 6 credits

Produce desktop published documents for organisation use

US2789 Internal 6 credits

Demonstrate knowledge of the principles of computer networks

US2797 Internal 4 credits

Demonstrate understanding of complex concepts of digital media

AS91634 (la) Internal 4 credits

Implement complex procedures to produce a specified digital media outcome

AS91635 (la) Internal 4 credits

Demonstrate understanding of areas of computer science

AS91636 (la) UElwra External 4 credits

Demonstrate understanding of wide area network technologies

AS91641 (la) UElra Internal 4 credits

Economics

Te Mātauranga Ōhanga

Economics is a social science about people and how they use resources. By studying economics, students become aware of the roles that individuals play in an economy, increase their understanding of economic events and improve their own decision making. Students explore the interactions between producers, consumers and governments and the impact economic decisions can have on society. Economics encourages students to think critically and independently about business, economic and social issues. This subject leads to careers in a range of fields including social policy and planning, business and financial management.

EC1000

Economics

NCEA Level 1 (course endorsement available)

In this course, students learn about producer and consumer choices, interactions between households and firms, how economic decisions are made, and the effects these choices have on individuals and the economy.

Students are introduced to the way producers work and the concept of a market that determines prices and allocates scarce resources. We are all involved in economics as producers or consumers and this course provides an understanding of our different roles in this process.

Recommended prior learning: Students should have a reasonable level of literacy.

This course is accessed through our online learning environment – My Te Kura.

Demonstrate understanding of consumer choices, using scarcity and/or demand

AS90983 (la) Pr Se Cr External 4 credits

Demonstrate understanding of decisions a producer makes about production

AS90984 (la) Pr Se Cr Internal 5 credits

Demonstrate understanding of producer choices using supply

AS90985 (la) Pr Se Cr External 3 credits

Demonstrate understanding of how consumer, producer and/or government choices affect society, using market equilibrium

AS90986 (la) Pr Se Cr External 5 credits

Demonstrate understanding of a government choice where affected groups have different viewpoints

AS90987 (la) Pr Se Cr Internal 4 credits

Demonstrate understanding of the interdependence of sectors of the New Zealand economy

AS90988 (la) Pr Se So Cr Internal 3 credits

EC2000

Economics

NCEA Level 2 (course endorsement available)

This course gives students the opportunity to explore major economic issues such as economic growth, unemployment, trade and inflation. Students develop the skills to define and measure these and analyse their causes and effects in the context of the New Zealand economy.

Students learn to use and evaluate economic models. The role of the government in the economy and the consequences of government policies are also explored. Students examine the interdependent nature of economies and compare and contrast the varying impacts of economic forces on different groups in society. This gives students a greater understanding of economic events and trends.

Recommended prior learning: Students should have a reasonable level of literacy.

This course is accessed through our online learning environment – My Te Kura.

Analyse inflation using economic concepts and models

AS91222 (la) UEIwa Se Cr External 4 credits

Analyse international trade using economic concepts and models

AS91223 (la) UEIwa Pr Se Cr External 4 credits

Analyse economic growth using economic concepts and models

AS91224 (la) UEIwa Se Cr External 4 credits

Analyse unemployment using economic concepts and models

AS91225 (la) Cr Internal 4 credits

Analyse statistical data relating to two contemporary economic issues

AS91226 (lna) UEna Se Cr Internal 4 credits

Analyse how government policies and contemporary economic issues interact

AS91227 (la) UEIra Se So Cr Internal 6 credits

EC3000**Economics**

NCEA Level 3 (course endorsement available)

Students develop and improve economic understanding of a range of social and economic issues. There are three main areas of study. The first is based around resource allocation and the market and will look closely at the concepts of scarcity and opportunity cost, demand and supply, market analysis, and monopolies and other market structures.

The second area explores situations of market failure and looks at the role of government in the economy in correcting market failure. The third area looks at influences on the New Zealand economy as a whole, both internal and external, including the aims of government and the effects of government policies.

New Zealand Scholarship exams are designed to extend very high-achieving Level 3 students. Those who wish to enter the New Zealand Scholarship exam in this subject must discuss this option with their Te Kura subject teacher.

Recommended prior learning: Students should have a reasonable level of literacy.

This course is accessed through our online learning environment – My Te Kura. It includes a mix of interactive online modules and downloadable resources in PDF format.

Demonstrate understanding of the efficiency of market equilibrium

AS91399 (la) UElwra External 4 credits

Demonstrate understanding of the efficiency of different market structures using marginal analysis

AS91400 (la) UElwra External 4 credits

Demonstrate understanding of micro-economic concepts

AS91401 (la) UElra Internal 5 credits

Demonstrate understanding of government interventions to correct market failures

AS91402 (la) UElra Internal 5 credits

Demonstrate understanding of macro-economic influences on the New Zealand economy

AS91403 (la) UElwra External 6 credits

English

Te Reo Ingarihi

English is one of the three official languages and an essential tool for full participation in our personal, local, national and global communities. At Te Kura, the study of English supports students to extend their competency in the use of language in a variety of contexts including tertiary study and the workplace. Students develop a sense of their identity as New Zealanders and explore their heritage through the study of novels, films, short stories and shorter texts. They also develop critical thinking skills, which enables them to evaluate and challenge the thinking of others as well as contribute to important global debates.

The subject is structured to allow maximum flexibility in course design. Students follow a course that is linked to their learning needs and goals. They progress through the levels at their own pace. For NCEA, students select a pathway to follow but can change pathways at any time. Students are able to work towards the three literacy unit standards in all NCEA courses.

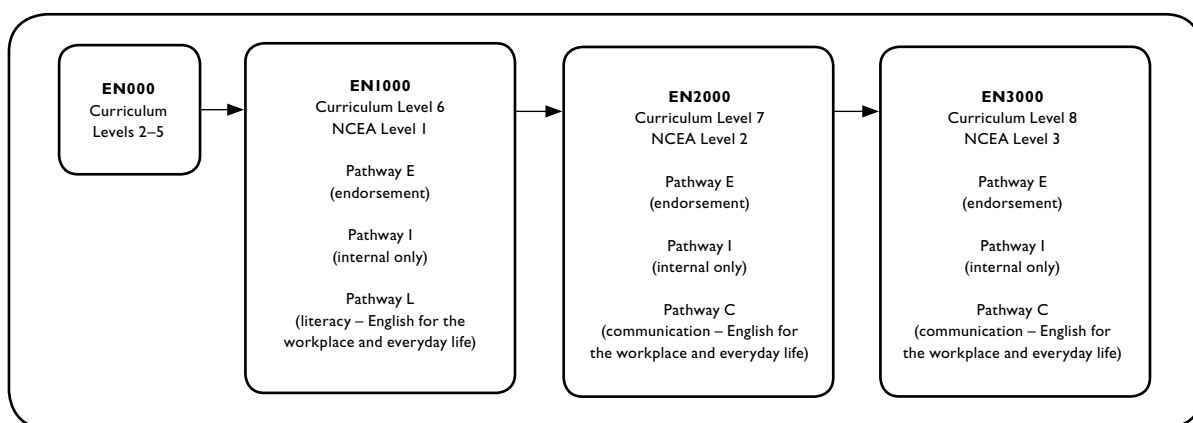

EN000

English

Curriculum Levels 2–5

This course is suited to students who are working at Curriculum Levels 2–5 in English and is personalised to meet individual learning needs. All aspects of English are covered, from reading, writing and speaking, through to listening, viewing and image-making exercises. This course helps students develop the skills they require to progress to NCEA English.

Recommended prior learning: No prior learning needed.

This course is accessed through our online learning environment – My Te Kura.

EN1000

English

NCEA Level 1 (course endorsement available)

The focus of Level 1 English is on students continuing to develop their understanding of purpose, audience, ideas, language and structure. Students study existing written, visual and oral texts as well as create their own.

Within the course, a student can take one of several pathways depending on their goals, interests and skills. English is structured to allow maximum flexibility in course design, so students can work at their own pace and alter their path at any time. All standards are available to all students, including the Literacy unit standards.

The initial pathways are:

- E (Endorsement) a full NCEA achievement standard programme with the opportunity to gain endorsement at the Merit or Excellence levels. To gain endorsement the qualification has to be completed in one academic year. Internal and external standards.
- I (Internal) an internal achievement standard programme, with the ability to meet the NCEA literacy requirement through achievement standards. Internal standards only.
- L (Literacy) English for work and everyday life: A combination of unit standards that develop communication skills in practical contexts. Students in this pathway will work towards gaining unit standard Literacy. Achievement standards will also be accessible through this pathway.

The choice of pathway will determine the first modules students will complete. Students will then plan a programme in consultation with their teacher.

Recommended prior learning: Working at Curriculum Levels 5–6 in English.

This course is accessed through our online learning environment – My Te Kura.

Express ideas in writing and write an original story

US1273 Pr Cr Internal 4 credits

Fill in a form

US3483 Pr So Cr Internal 2 credits

Complete an incident report

US3490 Pr So Cr Internal 2 credits

Demonstrate knowledge of and apply listening techniques

US3501 Pr So Cr Internal 3 credits

Write formal personal correspondence

US10792 Pr Cr Internal 3 credits

Read texts for practical purposes

US25060 Internal 2 credits

Write to communicate ideas for a purpose and audience

US26622 (lu) Internal 4 credits

Read texts with understanding

US26624 (lu) Internal 3 credits

Actively participate in spoken interactions

US26625 (lu) Internal 3 credits

Produce creative writing

AS90052 (la) Co Ma Pr Se So Cr Internal 3 credits

Produce formal writing

AS90053 (la) Co Ma Pr Se So Cr Internal 3 credits

Show understanding of specified aspect(s) of studied written text(s), using supporting evidence

AS90849 (la) Co Ma Pr Se So Cr External 4 credits

Show understanding of specified aspect(s) of studied visual or oral text(s), using supporting evidence

AS90850 (la) Co Ma Pr Se So Cr External 4 credits

Show understanding of significant aspects of unfamiliar written text(s) through close reading, using supporting evidence

AS90851 (la) Co Ma Pr Se So Cr External 4 credits

Explain significant connection(s) across texts, using supporting evidence

AS90852 (la) Co Ma Pr Se So Cr Internal 4 credits

Use information literacy skills to form conclusion(s)

AS90853 (la) Co Ma Pr Se So Cr Internal 4 credits

Form personal responses to independently read texts, supported by evidence

AS90854 (la) Co Ma Pr Se So Cr Internal 4 credits

Create a visual text

AS90855 (la) Co Ma Pr Se So Cr Internal 3 credits

Show understanding of visual and/or oral text(s) through close viewing and/or listening, using supporting evidence

AS90856 (la) Co Ma Pr Se So Cr Internal 3 credits

Construct and deliver an oral text

AS90857 (la) Co Ma Pr Se So Cr Internal 3 credits

EN2000

English

NCEA Level 2 (course endorsement available)

The focus of Level 2 English is on students developing an increasingly sophisticated understanding of purpose, audience, ideas, language and structure. Students analyse existing written, visual and oral texts as well as create their own.

Within the course, a student can take one of several pathways depending on their goals, interests and skills. English is structured to allow maximum flexibility in course design, so students can work at their own pace and alter their path at any time. All standards are available to all students.

The initial pathways are:

- E (Endorsement)** a full NCEA achievement standard programme with the opportunity to gain endorsement at the Merit or Excellence levels. Internal and external standards.
- I (Internal)** an internal achievement standard programme, with a focus on meeting the University Entrance literacy requirement (five reading and five writing credits at Level 2 or above). Internal standards only.
- C (Communication – English for work and everyday life)** A combination of achievement standards and unit standards that develop communication skills in practical contexts.

The choice of pathway will determine the first modules students will complete. Students will then plan a programme in consultation with their teacher.

Recommended prior learning: NCEA Level 1 or equivalent in English.

This course is accessed through our online learning environment – My Te Kura.

Be interviewed in a formal interview

US1294 Cr Pi Sc Internal 2 credits

Be assertive in a range of specified situations

US1299 Pr So Cr Internal 4 credits

Select, read, and assess texts on a topic

US2989 Ma Pr SSe Cr Internal 3 credits

Write business correspondence for a workplace

US3488 Cr Sc Internal 3 credits

Write a short report

US3492 Pr SSo SCr Internal 3 credits

Analyse specified aspect(s) of studied written text(s), supported by evidence

AS91098 (la) UElwra Co Ma Pr Se So Cr External 4 credits

Analyse specified aspect(s) of studied visual or oral text(s), supported by evidence

AS91099 (la) UElwa Co Ma Pr Se So Cr External 4 credits

Analyse significant aspects of unfamiliar written text(s) through close reading, supported by evidence

AS91100 (la) UElwra Co Ma Pr Se So Cr External 4 credits

Produce a selection of crafted and controlled writing

AS91101 (la) UElwa Co Ma Pr Se So Cr Internal 6 credits

Construct and deliver a crafted and controlled oral text

AS91102 (la) Co Pr Se So Cr Internal 3 credits

Create a crafted and controlled visual and verbal text

AS91103 (la) Co Pr Se So Cr Internal 3 credits

Analyse significant connections across texts, supported by evidence

AS91104 (la) Co Pr Se So Cr Internal 4 credits

Use information literacy skills to form developed conclusion(s)

AS91105 (la) UElra Co Ma Pr Se So Cr Internal 4 credits

Form developed personal responses to independently read texts, supported by evidence

AS91106 (la) UElra Co Ma Pr Se So Cr Internal 4 credits

Analyse aspects of visual and/or oral text(s) through close viewing and/or listening, supported by evidence

AS91107 (la) Cr Internal 3 credits

EN3000

English

NCEA Level 3 (course endorsement available)

EN3000 is the course for all students taking English for Level 3. The focus is on skills in 'making and creating meaning', through a range of texts in written, visual and oral forms. At Level 3 our skills reflect the sophistication of the text and our audience through critical response.

Within the course, a student can take one of several pathways depending on their goals, interests and skills. Students can alter their path at any time. All standards are available to all students.

Here are the initial options:

E (Endorsement) A full NCEA programme with the opportunity to gain endorsement at the Merit or Excellence levels – internal and external standards.

I (Internal) A focus on gaining University Entrance with internal standards.

C (Communication – English for work and everyday life) A combination of achievement standards and unit standards that develop communication skills in practical contexts. The initial choice will determine the first materials students will complete. Students will then plan their programme in consultation with their teacher.

Recommended prior learning: NCEA Level 2 or equivalent in English.

This course is accessed through our online learning environment – My Te Kura.

Write in plain English

US1279 Internal 3 credits

Write a report

US3491 Internal 4 credits

Respond critically to specified aspect(s) of studied written text(s), supported by evidence

AS91472 (la) UElwra External 4 credits

Respond critically to specified aspect(s) of studied visual or oral text(s), supported by evidence

AS91473 (la) UElwa External 4 credits

Respond critically to significant aspects of unfamiliar written texts through close reading, supported by evidence

AS91474 (la) UElwra External 4 credits

Produce a selection of fluent and coherent writing which develops, sustains, and structures ideas

AS91475 (la) UElwa Internal 6 credits

Create and deliver a fluent and coherent oral text which develops, sustains, and structures ideas

AS91476 (la) Internal 3 credits

Create a fluent and coherent visual text which develops, sustains, and structures ideas using verbal and visual language

AS91477 (la) Internal 3 credits

Respond critically to significant connections across texts, supported by evidence

AS91478 (la) Internal 4 credits

Develop an informed understanding of literature and/or language using critical texts

AS91479 (la) UElra Internal 4 credits

Respond critically to significant aspects of visual and/or oral text(s) through close reading, supported by evidence

AS91480 (la) Internal 3 credits

Enterprise Studies

Ngā Akoranga Hinonga

In today's world it's important to be financially capable. Enterprise Studies develops students' ability to make informed and effective decisions about the personal use and management of money matters. To achieve this, students need an understanding of their own and others' values. Students build knowledge and skills in managing money and income, setting goals and planning ahead. Being financially literate will enable them to keep more of the money they earn and do more with the money they spend and empower them as consumers to make the right choices for themselves. It gives students an understanding of how to manage their finances in the real world in order to avoid unnecessary risks and debt.

ES000

Enterprise Studies

Curriculum Levels 4–5

This course aims to help students to become informed about financial matters. It teaches them to manage their earnings, savings, spending, debt and budget. It helps students to set and prioritise their financial goals. They will understand that they have limited resources and, to fulfil their unlimited needs and wants, they need to make wise choices about how to manage their money.

This course also focuses on being enterprising by looking at successful entrepreneurs, being innovative, developing business plans, and taking and managing business risks. Throughout this course they will consider financial impacts on their personal life, their whānau/family and the wider community.

Recommended prior learning: No prior learning needed.

This course is accessed through our online learning environment – My Te Kura.

French

Te Reo Wīwī

Learning French introduces you not only to a new language but to a culture and society as well. Languages can bring people together and French is widely used for communicating in many parts of the world, including our Pacific neighbours New Caledonia and French Polynesia. People who know French can share in the rich traditions and history of France, a country that continues to fascinate the rest of the world, be it on the rugby field, in the arts or in its culinary reputation. The ability to speak French can help with travel, business and political interactions around the world.

FR000

Beginners' French

Curriculum Levels 1–5

This introductory course is designed to enable learners to communicate using basic French in everyday situations. Topics covered include: greetings, talking about yourself and family, your likes and opinions, daily life in the French-speaking world, where you live, shopping, eating and your typical day and holidays. Students build a repertoire of vocabulary, grammar and formulaic expressions to give them mastery of reading, speaking, writing and listening to elementary French.

As well as language development, the course introduces learners to intercultural aspects of learning French, requiring them to reflect on their own culture and attitudes in relation to what they learn about other cultural values and practices. An appreciation of cultural differences and similarities enables learners to competently negotiate their way through situations such as how to address people and how to behave appropriately in a variety of contexts.

The course consists of 16 online interactive modules, each of which may take 8–10 hours to complete (a total of 130–160 hours). Students typically cover the course in two years, but may complete it more rapidly.

Recommended prior learning: No prior learning needed.

This course is accessed through our online learning environment – My Te Kura.

Students will be required to make and submit audio and/or video recordings, so a microphone and camera or mobile device are required.

FRI000

French

NCEA Level 1 (course endorsement available)

In this NCEA Level 1 course there is a focus on both written and spoken French. It builds on the basic reading, speaking, writing and listening skills acquired in the Beginners' French (FR000) course. Topics are set to reflect situations students may encounter, including visiting France, holidays and travel, leisure activities, talking about their country, meals and health and staying in touch.

This one-year course consists of 10 online interactive modules, each of which may take approximately ten hours to complete (a total of 100 hours). Students can sit NCEA internal and/or external achievement standards towards NCEA Level 1. The course currently offers a total of 19 credits.

Recommended prior learning: Year 10 French or equivalent or have a French language background.

This course is accessed through our online learning environment – My Te Kura.

Students will be required to make and submit audio and/or video recordings, so a microphone and camera or mobile device are required.

Demonstrate understanding of a variety of spoken French texts on areas of most immediate relevance

AS90878 Pr Se So Cr External 5 credits

Give a spoken presentation in French that communicates a personal response

AS90879 Pr Internal 4 credits

Demonstrate understanding of a variety of French texts on areas of most immediate relevance

AS90881 Se External 5 credits

Write a variety of text types in French on areas of most immediate relevance

AS90882 Se Cr Internal 5 credits

FR2000**French**

NCEA Level 2 (course endorsement available)

This course offers further development in the skills of reading, speaking, writing and listening as well as building on students' intercultural awareness, enabling them to become increasingly competent in French-speaking situations. Themes include France and Europe, fashion, health, technology and the future, French–New Zealand links and travelling in France and French-speaking countries.

Taking advantage of technology to communicate in real time, students are encouraged to interact regularly with their teacher to hone their conversational skills, build their confidence and develop a range of language that will enable them to manage in a variety of situations.

Recommended prior learning: NCEA Level 1 French or equivalent.

This course is accessed through our online learning environment – My Te Kura.

Students will be required to make and submit audio and/or video recordings, so a microphone and camera or mobile device are required.

Demonstrate understanding of a variety of spoken French texts on familiar matters

AS91118 Se Cr External 5 credits

Interact using spoken French to share information and justify ideas and opinions in different situations

AS91119 SSe So Cr Internal 5 credits

Give a spoken presentation in French that communicates information, ideas and opinions

AS91120 Internal 4 credits

Demonstrate understanding of a variety of written and/or visual French text(s) on familiar matters

AS91121 Se External 5 credits

Write a variety of text types in French to convey information, ideas, and opinions in genuine contexts

AS91122 Se Cr Internal 5 credits

FR3000**French**

NCEA Level 3 (course endorsement available)

This course offers further development in the skills of reading, speaking, writing and listening as well as building on students' intercultural awareness, which enables them to become increasingly competent in French-speaking situations. Themes include France and Europe, fashion, health, technology and the future, French–New Zealand links and travelling in France and French-speaking countries.

Taking advantage of technology to communicate in real time, students are encouraged to interact regularly with their teacher to hone their conversational skills, build their confidence and develop a range of language that will enable them to manage a variety of situations.

Recommended prior learning: NCEA Level 2 French or equivalent.

This course is accessed through our online learning environment – My Te Kura. It includes a mix of interactive online modules and downloadable resources in PDF format.

Students will be required to make and submit audio and/or video recordings, so a microphone and camera or mobile device are required.

Demonstrate understanding of a variety of extended spoken French texts

AS91543 External 5 credits

Give a clear spoken presentation in French that communicates a critical response to stimulus material

AS91544 Internal 3 credits

Interact clearly using spoken French to explore and justify varied ideas and perspectives in different situations

AS91545 Internal 6 credits

Demonstrate understanding of a variety of extended written and/or visual French texts

AS91546 External 5 credits

Write a variety of text types in clear French to explore and justify varied ideas and perspectives

AS91547 Internal 5 credits

Gateway/STAR

Ngā Pokenga Mahi/STAR

Gateway is a tailored programme for students who have a chosen career path and want to gain the skills and experience needed to further their goals. Structured around work-based learning, Gateway allows students to learn and work while still at school. Full-time students and young adults in a full-time course in Years 11 to 13 can apply for Gateway and complete a work placement and learning plan, which will give them confidence to go out and achieve their goals.

STAR offers students access to short tertiary courses, either to explore an area of interest, e.g. Barista, or find out more about a particular tertiary course, e.g. Hospitality.

GATEWAY

Gateway

NCEA Levels 1–3

The Gateway programme is a structured, work-based learning programme in a vocational pathway of a student's choice. The Gateway co-ordinator works with each student to develop an individual Gateway learning plan related to the student's particular workplace and industry.

Students must arrange and complete a work placement of at least 10 days. The Gateway co-ordinator will help with this where needed. Over the duration of the work placement, students will receive on-the-job training from their workplace supervisor.

Gateway applications are welcome from our full-time and young adult students in a full time programme and Years 11 to 13 students who are work ready. Places are limited. Read more about Gateway on our website www.tekura.school.nz.

Recommended prior learning: No prior learning needed.

STAR

STAR

NCEA Levels 1–3

STAR courses are short courses at polytechnics or private training providers specifically designed for secondary school students. Courses give students an introduction to training for a particular trade or skill. They range in length from a single day, several days in a row or one day a week for up to two terms.

STAR courses are not a subject, rather they complement the students' studies at Te Kura. However, it is possible to gain unit standards and these credits can be used towards NCEA.

A secondary-tertiary advisor for each region advertises available programmes through the Te Kura website or through the student's learning advisor.

Students accepted onto STAR courses are typically in Years 11 to 13 and enrolled as a full time student, or a young adult studying three or more subjects. Year 10 students may apply for taster courses and in some exceptional circumstances may be referred by their teacher for a unit standard course.

Dual students are not eligible for STAR courses at Te Kura.

Te Kura also arranges some courses just for our students. These include outdoor education camps, Learner Licence, first aid courses and tertiary distance courses. Read more about STAR on our website www.tekura.school.nz.

Recommended prior learning: No prior learning needed.

Geography

Te Mātauranga Mātai Matawhenua

Geography explores the relationships and connections between people and their natural and cultural environments. Geography investigates the ways in which features are arranged on the earth's surface and describes and explains the patterns and processes that create them. Students learn to think spatially and use maps, visual images and new technologies to obtain, present and analyse information. Geography can be studied at tertiary level as a science or humanities subject. It leads to a wide variety of careers in environmental and urban planning and the public sector.

GY1000

Geography

NCEA Level 1 (course endorsement available)

This is an introduction to geography and its basic skills and concepts. Students learn how people interact with their natural and cultural environments through studies of population concepts, sustainability and the effects of extreme natural events.

Students learn how to draw and interpret maps, as well as how to interpret a variety of information and data. There is a focus on both New Zealand and global issues, which develops research and observation skills and gives students the ability to take action and solve problems.

Recommended prior learning: Students should have a reasonable level of literacy.

This course is accessed through our online learning environment – My Te Kura.

Demonstrate geographic understanding of environments that have been shaped by extreme natural event(s)

AS91007 (la) Pr Se Cr External 4 credits

Demonstrate geographic understanding of population concepts

AS91008 (la) Se So Cr External 4 credits

Demonstrate geographic understanding of the sustainable use of an environment

AS91009 (la) Pr Se Cr Internal 3 credits

Apply concepts and basic geographic skills to demonstrate understanding of a given environment

AS91010 (na) UEna Co Pr Se Cr External 4 credits

Conduct geographic research, with direction

AS91011 (lna) UEna Pr Se Internal 4 credits

Describe aspects of a contemporary New Zealand geographic issue

AS91012 (la) Se So Cr Internal 3 credits

Describe aspects of a geographic topic at a global scale

AS91013 (la) Pr Se Cr Internal 3 credits

GY2000

Geography

NCEA Level 2 (course endorsement available)

At this level, students study how a large natural environment has evolved over time and created specific landscape features. Students are also asked to consider the differences between developed and less developed countries and how these differences affect their people and society. Issues such as access to safe water and the generation of wind power are considered on both a national and an international level.

Basic geographic skills and techniques are expanded and the ability to analyse and interpret an array of data is developed. There is the opportunity to conduct a survey, process the results, reach conclusions and critically evaluate the research findings.

Recommended prior learning: Students should have a reasonable level of literacy.

This course is accessed through our online learning environment – My Te Kura.

Demonstrate geographic understanding of a large natural environment

AS91240 (la) UElwra Pr SSe External 4 credits

Demonstrate geographic understanding of differences in development

AS91242 (la) UElwra Se So External 4 credits

Apply geography concepts and skills to demonstrate understanding of a given environment

AS91243 (la) Co Pr Se Cr External 4 credits

Conduct geographic research with guidance

AS91244 (lna) UEna Se Cr Internal 5 credits

Explain aspects of a contemporary New Zealand geographic issue

AS91245 (la) Se So Cr Internal 3 credits

Explain aspects of a geographic topic at a global scale

AS91246 (la) Pr Se Internal 3 credits

GY3000**Geography**

NCEA Level 3 (course endorsement available)

This geography course involves detailed study of natural processes, such as volcanism, and cultural processes, such as tourism development. The decision-making processes for obtaining resource planning consent are examined. Advanced research skills are developed through topics of the student's choice that relate to environmental issues.

New Zealand Scholarship exams are designed to extend very high-achieving Level 3 students. Those who wish to enter the New Zealand Scholarship exam in this subject must discuss this option with their Te Kura subject teacher.

Recommended prior learning: Students should have a reasonable level of literacy.

This course is accessed through our online learning environment – My Te Kura.

Demonstrate understanding of how interacting natural processes shape a New Zealand geographic environment

AS91426 (la) UElwra External 4 credits

Demonstrate understanding of how a cultural process shapes geographic environment(s)

AS91427 (la) UElwra External 4 credits

Analyse a significant contemporary event from a geographic perspective

AS91428 (la) UElra Internal 3 credits

Demonstrate understanding of a given environment(s) through selection and application of geographic concepts and skills

AS91429 (la) UElwra External 4 credits

Conduct geographic research with consultation

AS91430 (lna) UEna Internal 5 credits

Analyse aspects of a contemporary geographic issue

AS91431 (la) UElra Internal 3 credits

Analyse aspects of a geographic topic at a global scale

AS91432 (la) Internal 3 credits

German

Te Reo Tiamana

Germany is a country with a long and rich heritage and is the geographic and cultural centre of Europe. The German language is closely related to English and is more similar to it than to any other language. There are 100 million German speakers throughout Europe, from Austria to Switzerland, and it is also a popular language in New Zealand. There are numerous close links between New Zealand and Germany through trade, tourism and exchanges, which makes knowledge of the German language and people an incredibly useful skill across many areas.

GR000

Beginners' German

Curriculum Levels 1–5

This is a two-part course for beginners (Curriculum Levels 1–3) and advanced beginners (Curriculum Levels 4–5). If students have had prior regular learning for German for about one school year or have some native speaker background, they may wish to consider starting with part two. For all other students, we advise starting with part one.

When enrolling in this course, students should indicate which part they want to enrol for. In the first part, students are introduced to basic listening, speaking, reading and writing skills using everyday German. They learn how to greet people and communicate basic information about themselves and others, including looks, hobbies, birthdays, family and home. They also learn to communicate about food, directions and what time it is.

German culture is also investigated to give students a broad understanding of the country and customs, behaviour and life in Germany.

In the second part, grammar and all language skills are covered in greater depth to increase students' confidence and language skills. Common and everyday aspects of German language and culture are at the centre of this part of the course. Students learn how to communicate further about their world, personality, family and interests.

Practical topics are also explored such as purchasing goods and communicating about holidays, festivals and the weather. Communication activities are emphasised throughout.

Recommended prior learning: Prior learning required for second part.

This course is accessed through our online learning environment – My Te Kura.

Students will be required to make and submit audio and/or video recordings, so a microphone and camera or mobile device are required.

GR1000

German

NCEA Level 1 (course endorsement available)

Students will consolidate their listening, speaking and reading skills and gain an understanding of basic German grammar and writing. There is a focus on communicating and aspects relating to home and family life, as well as a range of leisure activities. This course offers a broad insight into life in both Germany and New Zealand, and includes studies of some major German cities and areas.

Recommended prior learning: Students should have completed Year 10 German or equivalent or have a German language background.

This course is accessed through our online learning environment – My Te Kura.

Students will be required to make and submit audio and/or video recordings, so a microphone and camera or mobile device are required.

Demonstrate understanding of a variety of spoken German texts on areas of most immediate relevance

AS90883 Pr Se So Cr External 5 credits

Give a spoken presentation in German that communicates a personal response

AS90884 Pr Internal 4 credits

Demonstrate understanding of a variety of German texts on areas of most immediate relevance

AS90886 Se External 5 credits

Write a variety of text types in German on areas of most immediate relevance

AS90887 Se Cr Internal 5 credits

GR2000**German**

NCEA Level 2 (course endorsement available)

Students consolidate and extend their German language skills and further develop their understanding of life in Germany. There is an emphasis on advancing students' ability to communicate verbally and through writing, and students extensively build on their vocabulary and grammar.

Topics explored are theme based and focus on everyday situations, including aspects relating to social and school life and looking at the environment, youth and future careers. Social and economic relationships between New Zealand and Germany are discussed alongside a broader investigation into cultural issues where students learn about Berlin, Germany's multi-cultural population and other German-speaking nations.

Recommended prior learning: NCEA Level 1 German or equivalent.

This course is accessed through our online learning environment – My Te Kura.

Students will be required to make and submit audio and/or video recordings, so a microphone and camera or mobile device are required.

Demonstrate understanding of a variety of spoken German texts on familiar matters

AS91123 Se External 5 credits

Interact using spoken German to share information and justify ideas and opinions in different situations

AS91124 SSe So Cr Internal 5 credits

Give a spoken presentation in German that communicates information, ideas and opinions

AS91125 Internal 4 credits

Demonstrate understanding of a variety of written and/or visual German text(s) on familiar matters

AS91126 Se External 5 credits

Write a variety of text types in German to convey information, ideas, and opinions in genuine contexts

AS91127 Se Cr Internal 5 credits

GR3000**German**

NCEA Level 3 (course endorsement available)

This course advances students' linguistic development and German language skills. It challenges them to read, write and speak German in unfamiliar contexts and using more complex language, which broadens their vocabulary, grammatical and written abilities.

The focus is built around various themes that explore different aspects of German culture, its people and events. Students are challenged to express their thoughts and opinions on topics, including traditional stories, media and the creative arts, in German as much as possible.

New Zealand Scholarship exams are designed to extend very high-achieving Level 3 students. Those who wish to enter the New Zealand Scholarship exam in this subject must discuss this option with their Te Kura subject teacher.

Recommended prior learning: NCEA Level 2 German or equivalent.

This course is accessed through our online learning environment – My Te Kura. It includes a mix of interactive online modules and downloadable resources in PDF format.

Students will be required to make and submit audio and/or video recordings, so a microphone and camera or mobile device are required.

Demonstrate understanding of a variety of extended spoken German texts

AS91548 External 5 credits

Give a clear spoken presentation in German that communicates a critical response to stimulus material

AS91549 Internal 3 credits

Interact clearly using spoken German to explore and justify varied ideas and perspectives in different situations

AS91550 Internal 6 credits

Demonstrate understanding of a variety of extended written and/or visual German texts

AS91551 External 5 credits

Write a variety of text types in clear German to explore and justify varied ideas and perspectives

AS91552 Internal 5 credits

Health Education

Mātauranga Hauora

In Health Education students consider their wellbeing, attitudes and values, and also work towards promoting the health of their community. Students have the opportunity to participate in a range of tasks, including considering ways to keep themselves safe in a variety of situations and learning effective ways to communicate to help develop healthy relationships.

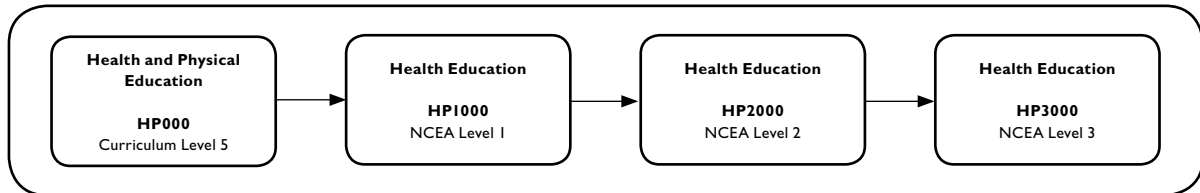

HP000

Health and Physical Education

Curriculum Level 5

In this course students explore health issues (such as wellbeing, nutrition, communication, decision making and problem solving) and safety issues (such as drug use and understanding gender and sexuality). Students also study physical education topics such as understanding the body, fitness testing, participating in a variety of activities and being involved in training programmes.

Recommended prior learning: No prior learning needed.

This is an online course available through our online learning environment, My Te Kura.

HP1000

Health Education

NCEA Level 1 (course endorsement available)

This course follows on from Health and Physical Education (HP000). In Health Education students explore health issues: the changing states of health, problem solving, understanding sexuality and safety issues around drug use.

The health topics offer 20 credits towards NCEA Level 1. There are four internal standards worth 16 credits and one external standard worth four credits. Health topics offer 20 literacy credits. To gain course endorsement students need to complete 14 credits in Health Education (this must include the exam).

Recommended prior learning: No prior learning needed.

This course is accessed through our online learning environment – My Te Kura.

Take action to enhance an aspect of personal well-being

AS90971 (1a) Pr Se So Cr Internal 3 credits

Demonstrate understanding of interpersonal skills used to enhance relationships

AS90973 (1a) Pr Se So Cr Internal 5 credits

Demonstrate understanding of strategies for promoting positive sexuality

AS90974 (1a) So Cr Internal 4 credits

Demonstrate understanding of issues to make health-enhancing decisions in drug-related situations

AS90975 (1a) Pr Se So Cr External 4 credits

Demonstrate understanding of ways in which well-being can change and strategies to support well-being

AS91097 (1a) Pr Se So Cr Internal 4 credits

HP2000**Health Education**

NCEA Level 2 (course endorsement available)

This course follows on from Health Education – NCEA Level 1 (HPI000) and is useful, often essential for students intending to continue with Level 3 Health Education courses.

Health Education offers students the opportunity to explore health issues, such as resiliency, improve wellbeing, understand sexuality and analyse an adolescent health issue.

The Health Education topics offer 20 credits towards NCEA Level 2. There are 3 internal standards worth 15 credits and 1 external standard worth 5 credits. These Health Education topics also offer 20 literacy credits.

To gain course endorsement students need to complete 14 credits in Health Education (which includes the exam).

Recommended prior learning: NCEA Level 1 Health Education or equivalent.

This course is accessed through our online learning environment – My Te Kura.

Analyse an adolescent health issue

AS91235 (la) Pr External 5 credits

Evaluate factors that influence people's ability to manage change

AS91236 (la) Pr Se SSo Internal 5 credits

Take action to enhance an aspect of people's well-being within the school or wider community

AS91237 (la) internal 5 credits

Analyse issues related to sexuality and gender to develop strategies for addressing the issues

AS91239 (la) Pr SSo Internal 5 credits

HP3000**Health Education**

NCEA Level 3 (course endorsement available)

This course follows on from Health Education – NCEA Level 2 (HP2000) and is often essential for students intending to continue with Health Education courses at tertiary institutions.

In Health Education students have the opportunity to explore New Zealand and an overseas health issue, evaluate health practices and analyse an ethical issue.

The Health Education topics offer 19 credits towards NCEA Level 3. There are 3 internal standards worth 14 credits and 1 external standard worth 5 credits. These Health Education topics also offer 19 literacy credits.

To gain course endorsement or entry to a tertiary institution you will need to complete 14 credits in Health Education (which includes an exam).

Recommended prior learning: NCEA Level 2 Health Education or equivalent.

This course is accessed through our online learning environment – My Te Kura.

Analyse a New Zealand health issue

AS91461 (la) UElra Internal 5 credits

Analyse an international health issue

AS91462 (la) UElwra External 5 credits

Evaluate health practices currently used in New Zealand

AS91463 (la) internal 5 credits

Analyse a contemporary ethical issue in relation to well-being

AS91464 (la) UElra Internal 4 credits

History

Kōrero Nehe

To understand the past is to understand the present. History gives students an insight into current world problems and New Zealand's identity and place in world events. It explores people and events and how they have influenced the world. History is not just about presenting the facts, but observing and questioning values and attitudes. Students improve their communication and writing skills, which enables them to express clear, convincing and well-thought-out arguments. From ancient civilisations to contemporary pop culture, from wars to peace treaties, history is both a fascinating and intellectually stimulating subject.

HS1000

History

NCEA Level 1 (course endorsement available)

Over the last 100 years, the world has undergone rapid and significant change. This course focuses on significant, and at times horrific, historical events throughout the 20th century. The effects of events that are studied can still be seen and can help to provide an understanding of today's international problems.

Students look at why peace did not last in the 1930s and the origins of World War II. Other conflicts investigated include Palestine and Israel, with a focus on the period 1935–2010, and race relations in apartheid-era South Africa.

New Zealand's past is also explored through topics about bicultural relations between Māori and Pākehā and the nation's search for security post-World War II.

Students also have the opportunity to undertake their own historical research project on either 'An Enemy of the State' or the 1981 Springbok rugby tour.

Recommended prior learning: Students should have a reasonable level of literacy.

This course is accessed through our online learning environment – My Te Kura.

Carry out an investigation of an historical event, or place, of significance to New Zealanders

AS91001 (la) Se So Cr Internal 4 credits

Demonstrate understanding of an historical event, or place, of significance to New Zealanders

AS91002 (la) Se So Cr Internal 4 credits

Interpret sources of an historical event of significance to New Zealanders

AS91003 (la) Se So Cr External 4 credits

Demonstrate understanding of different perspectives of people in an historical event of significance to New Zealanders

AS91004 (la) Se So Cr Internal 4 credits

Describe the causes and consequences of an historical event

AS91005 (la) Cr External 4 credits

Describe how a significant historical event affected New Zealand society

AS91006 (la) So Cr External 4 credits

HS2000

History

NCEA Level 2 (course endorsement available)

This course gives students an insight into the people and events that have shaped the modern world during the past 150 years. It was a period of significant change with the rise of nationalism, feminism, fascism and communism being just a few of the influential forces that emerged.

Students look into the origins of World War I, the conflict in Vietnam (1945–1975) and how these events affected New Zealand and the changing roles and opportunities for women in New Zealand from 1880–1960.

This course helps develop historical skills such as recognising and examining evidence and presenting information. Students undertake in-depth research work on either the end of World War I and the extent of New Zealand's contribution to the victory or an aspect of the home front in New Zealand during World War II.

Recommended prior learning: Students should have a good level of literacy.

This course is accessed through our online learning environment – My Te Kura.

Carry out an inquiry of an historical event or place that is of significance to New Zealanders

AS91229 (la) UEIra Se Cr Internal 4 credits

Examine an historical event or place that is of significance to New Zealanders
AS91230 (la) UElra Se Cr Internal 5 credits

Examine sources of an historical event that is of significance to New Zealanders
AS91231 (la) UElwra Cr External 4 credits

Interpret different perspectives of people in an historical event that is of significance to New Zealanders
AS91232 (la) UElra Cr Internal 5 credits

Examine causes and consequences of a significant historical event
AS91233 (la) UElwra Cr External 5 credits

Examine how a significant historical event affected New Zealand society
AS91234 (la) UElwra Cr External 5 credits

HS3000

History England 1558–1660

NCEA Level 3 (course endorsement available)

This course is an alternative to New Zealand in the 19th century – NCEA Level 3 (HS3200).

There are two main parts to this course.

Part one is external standards. Students make an in-depth study of Tudor and Stuart England from 1558 to 1660, which was a period of great upheaval and intrigue. Students look at how England was governed, issues facing monarchs, such as Elizabeth I and the early Stuart kings, and developments during the Civil War and Interregnum.

By exploring this time period, students learn about early modern English society and its economy, the religious changes that occurred and how these remain relevant even today.

Part two – For two internally assessed standards (AS91434 and AS91437), students will research a ‘contested historical event’ that they choose, but which must be approved by their teacher.

Events such as: the decision to drop an atomic bomb on Hiroshima, New Zealand’s involvement in the loss of Crete to German forces in 1941, the impact of New Zealand women gaining the vote, and whether the trial of Mary Stuart or Charles I was justified are examples of possible events that students may choose to research.

Students can also gain a third internal standard (AS91435) by analysing resources relating to the Treaty of Waitangi.

New Zealand Scholarship exams are designed to extend very high achieving Level 3 students. Those who wish to enter the New Zealand Scholarship exam in this subject must discuss this option with their Te Kura subject teacher.

Recommended prior learning: Students should have a very good level of literacy.

This course is accessed through our online learning environment – My Te Kura. It includes a mix of interactive online modules and downloadable resources in PDF format.

Research an historical event or place of significance to New Zealanders, using primary and secondary sources
AS91434 (la) UElra Internal 5 credits

Analyse an historical event, or place, of significance to New Zealanders
AS91435 (la) UElra Internal 5 credits

Analyse evidence relating to an historical event of significance to New Zealanders
AS91436 (la) UElwra External 4 credits

Analyse different perspectives of a contested event of significance to New Zealanders
AS91437 (la) UElra Internal 5 credits

Analyse the causes and consequences of a significant historical event
AS91438 (la) UElwra External 6 credits

Analyse a significant historical trend and the force(s) that influenced it
AS91439 (la) UElwra External 6 credits

HS3200**History New Zealand in the 19th century**

NCEA Level 3 (course endorsement available)

This course is an alternative to HS3000 History: England 1558–1660.

There are two main parts to this course.

Part one – For the external standards and one internal standard (AS91435) students will explore New Zealand in the 19th century: how Māori and Pākehā interacted, the economic and political changes that occurred, and social issues and attitudes that existed.

Students will look in detail at some major events in our history from the Treaty of Waitangi to the New Zealand Wars. New Zealand's development from isolation to settler society is also explored.

Part two – For two internally assessed standards (AS91434 and AS91437), students will research a 'contested historical event' that they choose but which must be approved by their teacher.

Events such as: the decision to drop an atomic bomb on Hiroshima, New Zealand's involvement in the loss of Crete to German forces in 1941, the impact of New Zealand women gaining the vote, and effects on Māori of large-scale Pākehā migration in the 19th century are examples of possible events that students may choose to research.

New Zealand Scholarship exams are designed to extend very high achieving Level 3 students. Those who wish to enter the New Zealand Scholarship exam in this subject must discuss this option with their Te Kura subject teacher.

Recommended prior learning: Students should have a very good level of literacy.

This course is accessed through our online learning environment – My Te Kura. It includes a mix of interactive online modules and downloadable resources in PDF format.

Research an historical event or place of significance to New Zealanders, using primary and secondary sources

AS91434 (la) UElra Internal 5 credits

Analyse an historical event, or place, of significance to New Zealanders

AS91435 (la) UElra Internal 5 credits

Analyse evidence relating to an historical event of significance to New Zealanders

AS91436 (la) UElwra External 4 credits

Analyse different perspectives of a contested event of significance to New Zealanders

AS91437 (la) UElra Internal 5 credits

Analyse the causes and consequences of a significant historical event

AS91438 (la) UElwra External 6 credits

Analyse a significant historical trend and the force(s) that influenced it

AS91439 (la) UElwra External 6 credits

Home Economics

Te Mātauranga Ohaoha Kāinga

In Home Economics students develop their understanding of the factors that influence wellbeing. There is a strong focus on food and nutrition. Students evaluate current issues and theories of nutrition and use this knowledge to make informed decisions about food. Through the processes of selecting, preparing, cooking and serving food, students develop creativity and personal skills crucial to everyday living. Issues relating to family and society are also explored, which aims to give students the ability and independence to plan for their future.

HE000

Home Economics

Curriculum Level 5

In this course students think critically about food and nutrition. Nutrition is fundamental to developing a sense of wellbeing to meet the growth and development needs of healthy, confident young people. The course offers opportunities for students to: examine and evaluate their food choices and food-related behaviour; challenge opinions and positions, take action to address food and nutrition-related issues and examine the influence of culture, tradition and media on food choices.

Recommended prior learning: No prior learning needed.

This course is accessed through our online learning environment – My Te Kura.

HE1000

Home Economics

NCEA Level I (course endorsement available)

Students learn how to use basic nutritional knowledge to make food choices that contribute to health and wellbeing. This course gives students a broader understanding of their own and others' nutritional demands. Safe food practices and preparation skills are taught and assessed. Societal and cultural influences are considered when looking at eating patterns.

Recommended prior learning: No prior learning needed.

This course is accessed through our online learning environment – My Te Kura.

Demonstrate knowledge of an individual's nutritional needs

AS90956 Pr Se So Internal 5 credits

Demonstrate understanding of societal influences on an individual's food choices and well-being

AS90957 (1a) Se So Internal 5 credits

Demonstrate understanding of how cultural practices influence eating patterns in New Zealand

AS90958 (1a) Se So Internal 5 credits

Demonstrate knowledge of practices and strategies to address food handling issues

AS90959 (1a) Pr Se So Internal 5 credits

Demonstrate understanding of how packaging information influences an individual's food choices and well-being

AS90961 (1a) Pr Se So External 4 credits

HE2000**Home Economics**

NCEA Level 2 (course endorsement available)

This course has a strong emphasis on taking action to enhance wellbeing. Students learn about sustainable health-enhancing change for individuals, communities and society. There is an opportunity for students to develop skills to formulate their own solutions.

Recommended prior learning: NCEA Level 1 Home Economics or equivalent.

This course is accessed through our online learning environment – My Te Kura.

Exercise informed choice in deciding on a major goods or service purchase

US7127 Cr Internal 2 credits

Describe legal implications of living in rented accommodation and means to prevent and resolve related problems

USI2354 Cr Internal 4 credits

Describe household conservation strategies

USI2359 Cr Internal 3 credits

Analyse issues related to the provision of food for people with specific food needs

AS91299 (la) Se So Internal 5 credits

Analyse the relationship between well-being, food choices and determinants of health

AS91300 (la) UElwa Se SSo External 4 credits

Analyse beliefs, attitudes and practices related to a nutritional issue for families in New Zealand

AS91301 (la) Internal 5 credits

Evaluate sustainable food related practices

AS91302 (la) Pr Se So Internal 5 credits

Analyse practices to enhance well-being used in care provision in the community

AS91303 (la) Se SSo Internal 5 credits

HE3000**Home Economics**

NCEA Level 3 (course endorsement available)

Students critically analyse current nutritional issues and there is scope to develop research skills and challenge their own attitudes and values.

Knowledge gained from previous studies in Home Economics and Health Education will be beneficial for students studying at this level. Home Economics NCEA Level 3 prepares students for tertiary education.

New Zealand Scholarship exams are designed to extend very high achieving Level 3 students. Those who wish to enter for the NZ Scholarship exam in this subject must discuss the option with their Te Kura subject teacher.

Recommended prior learning: A good level of literacy is required.

This course is accessed through our online learning environment – My Te Kura.

Investigate a nutritional issue affecting the well-being of New Zealand society

AS91466 (la) UElra Internal 5 credits

Analyse a food related ethical dilemma for New Zealand society

AS91468 (la) UElra Internal 5 credits

Investigate the influence of multinational food corporations on eating patterns in New Zealand

AS91469 (la) UElra Internal 5 credits

Analyse the influences of food advertising on well-being

AS91471 (la) UElwa External 4 credits

Japanese

Te Reo Hapanihi

Learning Japanese gives students the chance to communicate in a different language, and to gain an appreciation of a fascinating culture. Students develop their speaking and listening skills, as well as reading and using the unique kanji writing system, which can be a rewarding and enjoyable experience. Students will find knowledge of Japanese very helpful if they are planning on travelling to Japan or hosting Japanese visitors.

JP000

Beginners' Japanese

Curriculum Levels 1–5

This introductory course has two parts. Part one covers Curriculum Levels 1–3, and part two covers Curriculum Levels 4–5. Throughout the course, students develop speaking, listening, reading and writing skills. This includes learning to read and write Japanese script. An integral part of the course is learning about Japanese culture and gaining an intercultural understanding.

In part one, students learn how to introduce themselves, greet others, count, communicate while shopping and eating out and describe their family, daily routine, hobbies and interests. Hiragana script is covered as well as some katakana script. Students need to have completed part one (or equivalent previous study) before beginning part two.

In part two of the course, students learn colours and how to describe appearances, events, travel plans and holidays and their home and surroundings. Katakana script is completed and some kanji are introduced. Students also develop Japanese typing skills.

Recommended prior learning: For part two, students will need the equivalent of one year of learning and will need to be able to read and write hiragana.

This course is accessed through our online learning environment – My Te Kura.

Students will be required to make and submit audio and/or video recordings, so a microphone and camera or mobile device are required.

JP1000

Japanese

NCEA Level 1 (course endorsement available)

Students extend their reading, writing, listening and speaking skills through the experiences of a New Zealand student on a home stay in Japan. Within this theme, students cover aspects of daily life such as family relationships, travel preparations, hobbies and sports. Other topics include houses and furnishings, senior high school life and travelling by bullet train. Overall, there are approximately 60 kanji characters to learn.

Recommended prior learning: Students must have completed Year 10 Japanese or equivalent or have a Japanese language background. Ability to read and write hiragana is essential and knowledge of katakana is an advantage.

This course is accessed through our online learning environment – My Te Kura.

Students will be required to make and submit audio and/or video recordings, so a microphone and camera or mobile device are required.

Demonstrate understanding of a variety of spoken Japanese texts on areas of most immediate relevance

AS90893 Pr Se So Cr External 5 credits

Give a spoken presentation in Japanese that communicates a personal response

AS90894 Pr Internal 4 credits

Demonstrate understanding of a variety of Japanese texts on areas of most immediate relevance

AS90896 Se External 5 credits

Write a variety of text types in Japanese on areas of most immediate relevance

AS90897 Se Cr Internal 5 credits

JP2000**Japanese**

NCEA Level 2 (course endorsement available)

This course introduces about 75 new kanji characters and further extends the ability to read, write, speak and listen in Japanese. Topics covered include: the Japanese school system, land and people, leisure, work, family life, travel and tourism, eating and drinking.

Recommended prior learning: NCEA Level 1 Japanese course or equivalent.

This course is accessed through our online learning environment – My Te Kura.

Students will be required to make and submit audio and/or video recordings, so a microphone and camera or mobile device are required.

Demonstrate understanding of a variety of spoken Japanese texts on familiar matters

AS91133 Se Cr External 5 credits

Interact using spoken Japanese to share information and justify ideas and opinions in different situations

AS91134 SSe So Cr Internal 5 credits

Give a spoken presentation in Japanese that communicates information, ideas and opinions

AS91135 Internal 4 credits

Demonstrate understanding of a variety of written and/or visual Japanese text(s) on familiar matters

AS91136 Se External 5 credits

Write a variety of text types in Japanese to convey information, ideas, and opinions in genuine contexts

AS91137 Se Cr Internal 5 credits

JP3000**Japanese**

NCEA Level 3 (course endorsement available)

This course introduces about 70 new kanji characters and further extends the ability to read, write, speak and listen in Japanese. Topics covered include: work, leisure, family, travel and tourism, land and people, communication and the media. New Zealand Scholarship exams are designed to extend very high achieving Level 3 students. Those who wish to enter the New Zealand Scholarship exam in this subject must discuss this option with their Te Kura subject teacher.

Recommended prior learning: NCEA Level 2 Japanese course or equivalent.

This course is accessed through our online learning environment – My Te Kura. It includes a mix of interactive online modules and downloadable resources in PDF format.

Students will be required to make and submit audio and/or video recordings, so a microphone and camera or mobile device are required.

Demonstrate understanding of a variety of extended spoken Japanese texts

AS91553 External 5 credits

Give a clear spoken presentation in Japanese that communicates a critical response to stimulus material

AS91554 Internal 3 credits

Interact clearly using spoken Japanese to explore and justify varied ideas and perspectives in different situations

AS91555 Internal 6 credits

Demonstrate understanding of a variety of extended written and/or visual Japanese texts

AS91556 External 5 credits

Write a variety of text types in clear Japanese to explore and justify varied ideas and perspectives

AS91557 Internal 5 credits

Kaupapa Māori

Kaupapa Māori

Kaupapa Māori formally recognises Te Ao Māori, and Māori skills and knowledge, through the sub-fields listed below. Students add to their NCEA options by choosing standards from separate sub-fields, or from a range of sub-fields, and by linking authentic learning and achievement in Kaupapa Māori to learning and standards from many other NCEA courses.

Through Kaupapa Māori students have the opportunity to build on prior learning and experience and to develop new skills and insights. There are many opportunities to apply the skills and knowledge of Kaupapa Māori in community and whānau contexts, work exploration leading to job shadowing, internships, secondary-tertiary opportunities, and future education and employment opportunities.

The Māori economy is a significant contributor to the New Zealand economy overall, with opportunities across all sectors of society from government, local government, primary industries, manufacturing and tourism.

EM9000

Environment Māori

NCEA Level 1, NCEA Level 2, NCEA Level 3

Māori environmental practices are explored based on individual learner interests. Students demonstrate learning through their choice of oral presentations, visual presentations, written presentations, haka, whaikōrero or waiata, depending on the standard/s chosen.

Students are free to choose the standards that best suit their individual interests and needs.

While there may be flexibility for a blended approach, this course will primarily be accessed through our online learning environment – My Te Kura.

Recommended prior learning: No prior learning needed.

Explain the role of whakatauki in relation to how Māori manage the environment

US6138 Pr Cr Internal 2 credits

Describe aroha in relation to the way Māori interact with the natural world

US6139 Pr Internal 2 credits

Demonstrate knowledge of the use of rākau Māori

US15985 Internal 2 credits

Explain tikanga Māori for the use of rākau Māori in clothing, whare, waka and implements

US15987 Cr Internal 3 credits

Demonstrate knowledge of a native bird and its significance to Māori

US15990 Pr Cr Internal 2 credits

MM9000

Manaaki Marae

NCEA Level 2, NCEA Level 3

The Manaaki Marae sub-field is built around authentic, practical, and hands-on demonstration of learning. Students film themselves providing hospitality on the marae, or in an agreed context where the tikanga of the marae is demonstrated. While filming students explain in detail the cultural significance of what they are doing.

With careful planning students can achieve multiple Manaaki Marae standards from one marae hospitality event.

While there may be flexibility for a blended approach, this course will primarily be accessed through our online learning environment – My Te Kura.

Recommended prior learning: No prior learning needed.

Describe the roles and responsibilities of ringawera in a marae wharekai

US21232 SSe Internal 2 credits

Prepare, maintain and clear a buffet in a marae wharekai

US21248 SSe Internal 2 credits

Prepare and serve beverages in a marae wharekai

US21253 SSe Internal 2 credits

Describe manaaki in terms of the reciprocal interactions between the tangata whenua and manuhiri in a marae wharekai

US27509 Internal 4 credits

Identify traditional kai and describe the gathering process

US27510 Internal 2 credits

Prepare fruit and vegetables to present for manuhiri

US29566 Internal 3 credits

Prepare equipment and cook kai in an oven to present for manuhiri
US29567 Internal 4 credits

Prepare equipment and fry kai to present for manuhiri
US29568 Internal 4 credits

Prepare equipment and cook kai with liquid to present for manuhiri
US29569 Internal 6 credits

Plan, prepare, and produce a hāngi as part of a team, in accordance with tikanga and kāwa
US30540 Internal 5 credits

Prepare, cook, and present a range of dishes for manuhiri
US30541 Internal 15 credits

TK9000

Tikanga

NCEA Level 1, NCEA Level 2

Tikanga concepts, issues and practices are explored based on individual learner interests.

Students demonstrate learning through their choice of oral presentations, visual presentations, written presentations, performances, haka, whaikōrero or waiata depending on the standard/s chosen.

Students are free to choose the standards that best suit their individual interests and needs.

While there may be flexibility for a blended approach, this course will primarily be accessed through our online learning environment – My Te Kura.

Recommended prior learning: No prior learning needed.

Describe historical events of one hapū or iwi
US16044 SCr Internal 4 credits

Describe the life and achievements of a Māori leader
US16054 Cr Internal 3 credits

Describe the practices and processes associated with the welcome ceremony in accordance with Tikanga and/or kawa
US16142 Se So Cr Internal 2 credits

Describe the terms associated with whakapapa and use them within a family structure
US27106 Cr Internal 2 credits

Describe the protocols and roles associated with pōwhiri in accordance with tikanga and/or kawa
US27108 Cr Internal 2 credits

Explain the use of karakia in accordance with tikanga
US27129 Cr Internal 2 credits

TM9000

Tourism Māori

NCEA Level 3

Learning in Tourism Māori assists the learner to identify the uniqueness of Māori culture and enables the learner to gain an understanding of the interconnectedness of Te Ao Māori, to explain the differences for manuhiri and highlight the significance for tourism.

While there may be flexibility for a blended approach, this course will primarily be accessed through our online learning environment – My Te Kura.

Recommended prior learning: No prior learning needed.

Identify and explain the cultural significance of natural and manmade attractions in tourism Māori
US31071 Internal 6 credits

Legal Studies

Te Akoranga Taha Ture

Legal Studies covers a broad range of topics and aims to provide an understanding of the role of law in society and the basic processes and principles of the New Zealand legal system. Legal Studies explores and evaluates the ability of the legal system to provide just outcomes for all individuals and groups, giving students a better understanding of their legal rights and responsibilities. Students will develop an appreciation of how the legal system impacts on their lives and how they can influence and change it. This subject can lead to a range of possible careers including the legal profession, business, government service or agencies.

LG1000

Legal Studies

NCEA Level 1 (course endorsement not available)

In this Legal Studies course, students explore law as an integral aspect of society and find out how laws are made and applied in everyday life. Students consider why laws are developed and the characteristics of an effective law.

Students are able to demonstrate an understanding of the New Zealand court system, the law making process, and how New Zealanders vote for an MMP government. Other major areas of law covered include concepts of democracy and government such as rule of law, separation of powers and civil liberties, and different concepts of justice, such as coercive power and impartiality.

Recommended prior learning: Students should have a reasonable level of literacy.

This course is accessed through our online learning environment – My Te Kura.

Describe basic employment rights and responsibilities, and sources of information and/or assistance

US1978 Pr So Internal 3 credits

Demonstrate knowledge of assessing legal assistance

US8548 Pr SO Cr Internal 3 credits

Demonstrate understanding of concepts of democracy and government

US27835 Internal 4 credits

Demonstrate understanding of foundational concepts of justice

US27838 Internal 4 credits

Demonstrate understanding of concepts of law

US27841 Internal 4 credits

Demonstrate understanding of litigation and dispute resolution processes in New Zealand

US27844 Internal 4 credits

Demonstrate understanding of law making processes

US27847 Internal 4 credits

Demonstrate understanding of New Zealand's system of government and its formation and operation

US27850 Internal 4 credits

LG2000

Legal Studies

NCEA Level 2 (course endorsement not available)

This Legal Studies course enables students to develop an understanding of the role of law and its relationship to everyday life in New Zealand. Students will explore concepts of law such as crime, negligence and contract. They study litigation and dispute resolution processes used in New Zealand, how laws are reformed and different voting systems such as MMP and FPP.

Other major areas of law covered include concepts of democracy and government such as rule of law, separation of powers and liberal democracy, and different concepts of justice, such as restorative justice and marae justice.

Recommended prior learning: Students should have a good level of literacy.

This course is accessed through our online learning environment – My Te Kura.

Describe employment agreements

US1979 Cr Internal 3 credits

Describe factors contributing to, and consequences of, crime

US8545 Sc Internal 3 credits

Describe the application of New Zealand law to marriage, civil union, and de-facto relationships

US8551 Sc Internal 3 credits

Describe legal consequences and protections relating to domestic violence and child abuse

US8552 Sc Internal 3 credits

Describe the objectives and application of consumer law
US8555 Cr Sc Internal 3 credits

Describe the legal rights and personal responsibilities of secondary school students
US10337 Sc Internal 3 credits

Explain concepts of democracy and government in a New Zealand context
US27836 So Internal 4 credits

Explain concepts of justice
US27839 So Internal 4 credits

Explain concepts of law
US27842 So Internal 4 credits

Explain litigation and dispute resolution processes
US27845 So Internal 4 credits

Explain a law making process
US27848 SSo Internal 4 credits

Explain systems of government and their formation and operation in a New Zealand context
US27851 So Internal 4 credits

LG3000

Legal Studies

NCEA Level 3 (course endorsement not available)

Students at this level will be able to evaluate concepts and principles, and systems and processes of the New Zealand and other legal systems. They will explore the application of a concept of law such as crime or natural justice to real situations. Students study formal means of challenging state power, such as the Ombudsman used in New Zealand, and evaluate a law making process associated with a major issue such as film production in New Zealand.

Other major areas of law covered include concepts of democracy and government and different concepts of justice, evaluated in relation to specific situations such as significant events or particular legislation.

NCEA Level 3 Legal Studies is not on the NZQA approved subject list for University Entrance. However the unit standards gained in LG3000 can count towards the other 18 credits required for NCEA Level 3, which is a requirement for University Entrance.

Recommended prior learning: Students should have a very good level of literacy.

This course is accessed through our online learning environment – My Te Kura. It includes a mix of interactive online modules and downloadable resources in PDF format.

Demonstrate knowledge of the development of the New Zealand legal system
US10347 Internal 5 credits

Evaluate a concept of democracy and government in relation to restraint on state power
US27837 Internal 4 credits

Evaluate a concept of justice in relation to a specific situation
US27840 Internal 4 credits

Evaluate a concept of law in relation to a specific situation
US27843 Internal 4 credits

Evaluate litigation and dispute resolution processes in relation to challenging state power
US27846 Internal 4 credits

Evaluate a law making process in relation to a significant legal issue
US27849 Internal 4 credits

Evaluate systems of government and their formation
US27852 Internal 4 credits

Mathematics and Statistics

Te Mātauranga Pāngarau

Mathematics is more than just numbers. It is the exploration and use of patterns and relationships in quantities, space and time. Statistics focuses on patterns and relationships in data. Students are equipped with powerful communication and problem solving tools for investigating, interpreting and making sense of the world. Using symbols, graphs and diagrams to investigate patterns and relationships, students model real-life and hypothetical situations in a range of contexts: social, cultural, scientific, technological, health, environmental and economic. Mathematics and Statistics develops students' ability to think creatively, critically, strategically and logically. Students also learn to structure, organise, process and communicate information.

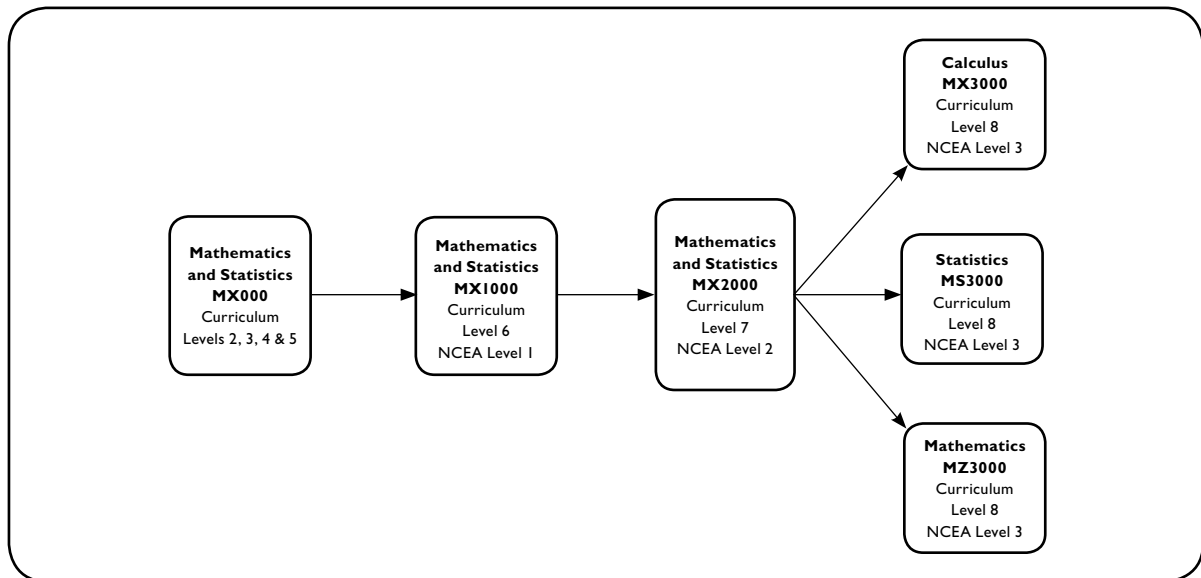

MX000

Mathematics and Statistics

Curriculum Levels 2–5

Individualised courses are designed to give students a strong basis in the fundamentals of mathematics and statistics and to build confidence in the development and application of basic skills.

Each curriculum level develops the concepts of statistics, probability, geometry, measurement, number and algebra, which are applied to practical problems. In the lower curriculum levels, the focus is on core skills of numeracy, measurement, money, reading tables and graphs, using a calculator, basic arithmetic and shape patterns. After mastering these, students progress towards an understanding of whole numbers, decimals, fractions, percentages and integers, and learn the skills needed to construct and interpret statistical graphs.

Other topics covered include: perimeter, area and volume, investigating mass, capacity, time and temperature, ratios, mean and range, exploring patterns, equations and locating position. Curriculum Level 5 is the foundation for NCEA Level 1.

Concepts are connected in new topics such as trigonometry. There is even greater emphasis on solving realistic problems using a variety of approaches and clearly and concisely communicating the thought processes.

Recommended prior learning: No prior learning needed.

This course is accessed through our online learning environment – My Te Kura.

MX1000

Mathematics and Statistics

NCEA Level 1 (course endorsement available)

This is a Level 1 course covering all areas of mathematics and statistics at Curriculum Level 6. Students learn the skills needed for mathematical processes with a focus on algebra, angle geometry and trigonometry and probability. Teaching is also available in number, measurement, statistics, constructions and transformations. Students can select from the achievement standards to a maximum total of 24 credits.

Recommended prior learning: Students should have studied mathematics at Curriculum Level 5 or equivalent.

This course is accessed through our online learning environment – My Te Kura.

Use number to solve problems

US26623 (nu) UEnu Internal 4 credits

Interpret statistical information for a purpose

US26626 (nu) UEnu Internal 3 credits

Use measurement to solve problems

US26627 (nu) UEnu Internal 3 credits

Apply numeric reasoning in solving problems

AS91026 (na) UEna Co Ma Pr Se So Cr Internal 4 credits

Apply algebraic procedures in solving problems

AS91027 (na) UEna Co Ma Pr Se So Cr External 4 credits

Investigate relationships between tables, equations and graphs

AS91028 (na) UEna Co Ma Pr Se Cr External 4 credits

Apply linear algebra in solving problems

AS91029 (na) UEna Co Ma Pr Se So Cr Internal 3 credits

Apply measurement in solving problems

AS91030 (na) UEna Co Ma Pr Se So Cr Internal 3 credits

Apply geometric reasoning in solving problems

AS91031 (na) UEna Co Ma Pr Se Cr External 4 credits

Apply right-angled triangles in solving measurement problems

AS91032 (na) UEna Co Ma Pr Se Cr Internal 3 credits

Apply knowledge of geometric representations in solving problems

AS91033 (na) UEna Co Ma Pr Cr Internal 3 credits

Apply transformation geometry in solving problems

AS91034 (na) UEna Co Ma Pr Se Cr Internal 2 credits

Investigate a given multivariate data set using the statistical enquiry cycle

AS91035 (lna) UEna Co Ma Pr Se So Cr Internal 4 credits

Investigate bivariate numerical data using the statistical enquiry cycle

AS91036 (lna) UEna Pr Se So Cr Internal 3 credits

Demonstrate understanding of chance and data

AS91037 (na) UEna Pr Se So Cr External 4 credits

MX2000

Mathematics and Statistics

NCEA Level 2 (course endorsement available)

This course covers all major areas of mathematics and statistics at Curriculum Level 7. Students learn skills needed for mathematical processes with a focus on algebra, geometry, measurement, probability and statistics. Students can select from the achievement standards to a maximum total of 24 credits.

Recommended prior learning: A minimum of 12–14 NCEA Level 1 Mathematics and Statistics achievement standard credits or equivalent. NCEA Level 1 numeracy unit standards are not sufficient prior learning.

This course is accessed through our online learning environment – My Te Kura.

Apply co-ordinate geometry methods in solving problems

AS91256 (na) UEna Ci Cr Mt Si Internal 2 credits

Apply graphical methods in solving problems

AS91257 (na) UEna Ci Cr Mt Pi Si Internal 4 credits

Apply sequences and series in solving problems

AS91258 (na) UEna Ci Cr Mt Pi Sc Internal 2 credits

Apply trigonometric relationships in solving problems

AS91259 (na) UEna Ci Cr Mt Internal 3 credits

Apply network methods in solving problems

AS91260 (na) UEna Ci Cr Mt Pi Sc Si Internal 2 credits

Apply algebraic methods in solving problems

AS91261 (na) UEna Ci Cr Mt Pi External 4 credits

Apply calculus methods in solving problems

AS91262 (na) UEna Ci Cr Mt Pi External 5 credits

Design a questionnaire

AS91263 (lna) UEna Cr Pi Sc Si Internal 3 credits

Use statistical methods to make an inference

AS91264 (lna) UEna Cr Pi Sc Si Internal 4 credits

Evaluate a statistically based report

AS91266 (lna) UElma Ci Cr Mt Pi Si Internal 2 credits

Apply probability methods in solving problems

AS91267 (lna) UEna Cr Pi Sc Si External 4 credits

Apply systems of equations in solving problems

AS91269 (na) UEna Ci Cr Mt Internal 2 credits

MX3000**Calculus**

NCEA Level 3 (course endorsement available)

This course is designed to prepare the student for the study of mathematics, pure and applied sciences or engineering at a tertiary level. The focus is on calculus, with students encountering algebra and trigonometry topics, as well as the manipulation of real and complex numbers and geometry and conic sections. Students can select from the achievement standards to a maximum total of 24 credits.

Recommended prior learning: A minimum of 12–14 NCEA Level 2 Mathematics and Statistics credits or equivalent.

This course is accessed through our online learning environment – My Te Kura.

Apply the geometry of conic sections in solving problems

AS91573 (na) UEna Internal 3 credits

Apply linear programming methods in solving problems

AS91574 (na) UEna Internal 3 credits

Apply trigonometric methods in solving problems

AS91575 (na) UEna Internal 4 credits

Use critical path analysis in solving problems

AS91576 (na) UEna Internal 2 credits

Apply the algebra of complex numbers in solving problems

AS91577 (na) UEna External 5 credits

Apply differentiation methods in solving problems

AS91578 (na) UEna External 6 credits

Apply integration methods in solving problems

AS91579 (na) UEna External 6 credits

Apply systems of simultaneous equations in solving problems

AS91587 (na) UEna Internal 3 credits

MS3000**Statistics**

NCEA Level 3 (course endorsement available)

Students interested in the analysis and interpretation of quantitative data will find this course useful. With a focus on statistics, this course explores probability, sampling and statistical inference as well as the analysis of time series and bivariate data. Part of this course is writing reports that justify the findings of an analysis.

This course is appropriate as a foundation in statistical exploration to support any area of study at tertiary level, especially the biological sciences, social sciences or commerce.

Access to statistical software, such as iNZight or NZgrapher for internal standards and a graphing or CAS calculator for external exams is essential. Students can select from the following achievement standards to a maximum total of 24 credits.

Recommended prior learning: A minimum of 12–14 NCEA Level 2 Mathematics and Statistics credits or equivalent.

This course is accessed through our online learning environment – My Te Kura.

Investigate time series data

AS91580 (Ina) UEna Internal 4 credits

Investigate bivariate measurement data

AS91581 (Ina) UEna Internal 4 credits

Use statistical methods to make a formal inference

AS91582 (Ina) UEna Internal 4 credits

Conduct an experiment to investigate a situation using experimental design principles

AS91583 (Ina) UEna Internal 4 credits

Evaluate statistically based reports

AS91584 (Ina) UEnlwa External 4 credits

Apply probability concepts in solving problems

AS91585 (na) UEna External 4 credits

Apply probability distributions in solving problems

AS91586 (na) UEna External 4 credits

MZ3000**Mathematics**

NCEA Level 3 (course endorsement available)

This course takes a number of achievement standards from the Calculus and Statistics courses and creates a blended course. The focus of this course is on linear programming, networks, calculus and trigonometry, with students also having an opportunity to develop statistical and probabilistic skills encountered in time series, statistical reports, bivariate analysis and statistical inference.

Students can select from the following achievement standards to a maximum total of 24 credits.

Recommended prior learning: A minimum of 12–14 NCEA Level 2 Mathematics and Statistics credits or equivalent.

This course is accessed through our online learning environment – My Te Kura.

Apply linear programming methods in solving problems

AS91574 (na) UEna Internal 3 credits

Apply trigonometric methods in solving problems

AS91575 (na) UEna Internal 4 credits

Use critical path analysis in solving problems

AS91576 (na) UEna Internal 2 credits

Apply differentiation methods in solving problems

AS91578 (na) UEna External 6 credits

Investigate time series data

AS91580 (lna) UEna Internal 4 credits

Investigate bivariate measurement data

AS91581 (lna) UEna Internal 4 credits

Use statistical methods to make a formal inference

AS91582 (lna) UEna Internal 4 credits

Evaluate statistically based reports

AS91584 (lna) UEnlwa External 4 credits

Apply systems of simultaneous equations in solving problems

AS91587 (na) UEna Internal 3 credits

Media Studies

Te Akoranga Pāpāho

In Media Studies students learn various journalism, close reading and analytical skills. Students can create their own media product through studies in representation, genre, and narrative. Media Studies enables students to be more media aware and savvy, which are vital skills in today's society.

MDI000

Media Studies

NCEA Level 1 (course endorsement available)

Level 1 Media Studies looks at many aspects of the media including: film, television, radio, print, social networks and the internet. Students work closely with their teacher to work out an appropriate programme based on their strengths, interests and literacy.

Recommended prior learning: Students will need to have strong literacy and computer skills and have worked successfully in literacy rich subjects at NCEA Level 1.

This course is accessed through our online learning environment – My Te Kura.

Demonstrate understanding of how individuals interact with the media

AS90989 (1na) UEna Se Cr Internal 3 credits

Demonstrate understanding of selected elements of media text(s)

AS90990 (1a) Cr Internal 3 credits

Demonstrate understanding of characteristics of a media genre

AS90992 (1a) Se Cr External 4 credits

Produce a design and plan for a media product using a specified range of conventions

AS90993 Se Cr Internal 3 credits

Complete a media product from a design and plan using a specified range of conventions

AS90994 Cr Internal 6 credits

Write media texts for a specific target audience

AS90996 (1a) Se Cr Internal 3 credits

MD2000

Media Studies

NCEA Level 2 (course endorsement available)

Level 2 Media Studies looks at many aspects of the media including: film, print, social networks and the internet. Students work closely with their teacher to work out an appropriate programme based on their strengths, interests and literacy.

Recommended prior learning: Students will need to have strong literacy and computer skills and have worked successfully in literacy rich subjects at NCEA Level 1.

This course is accessed through our online learning environment – My Te Kura.

Demonstrate understanding of narrative in media texts

AS91249 (1a) SCr Internal 4 credits

Demonstrate understanding of representation in the media

AS91250 (1a) SCr Internal 3 credits

Demonstrate understanding of an aspect of a media genre

AS91251 (1a) UElwra SCr External 4 credits

Produce a design and plan for a developed media product using a range of conventions

AS91252 (1a) SCr Internal 4 credits

Complete a developed media product from a design and plan using a range of conventions

AS91253 (1a) SCr Internal 6 credits

Write developed media text for a specific target audience

AS91255 (1a) UElwa Se SCr Internal 3 credits

MD3000**Media Studies**

NCEA Level 3 (course endorsement available)

Level 3 Media Studies looks at many aspects of the media including: film, television, print, social networks and the internet. Students work closely with their teacher to work out an appropriate programme based on their strengths, interests and literacy.

Recommended prior learning: Students will need to have strong literacy and computer skills and have worked successfully in literacy rich subjects at NCEA Level 2.

This course is accessed through our online learning environment – My Te Kura.

Demonstrate understanding of the meaning of a media text through different readings

AS91491 (la) Internal 3 credits

Demonstrate understanding of the media representation of an aspect of New Zealand culture or society

AS91492 (la) Internal 3 credits

Demonstrate understanding of a relationship between a media genre and society

AS91493 (la) UElwra External 4 credits

Produce a design for a media product that meets the requirements of a brief

AS91494 (la) Internal 4 credits

Produce a media product to meet the requirements of a brief

AS91495 (la) Internal 6 credits

Write a media text to meet the requirements of a brief

AS91497 (la) UElwa Internal 3 credits

Music

Te Mātauranga Pūoru

Music is a fundamental form of personal and cultural expression. By making, sharing and responding to music, students have opportunities to nurture their own creative potential as well as lay a foundation for lifelong enjoyment of and participation in music.

MC000

General Music

Curriculum Level 5

This course helps students nurture their enjoyment of music. It offers opportunities in a wide range of different styles and types of music activities, and those students intending to do music at NCEA levels can develop appropriate skills and knowledge.

Students are strongly encouraged to have their own instrument (voice is an instrument) and have access to a music mentor within their own community.

Recommended prior learning: No prior learning needed.

This course is accessed through our online learning environment – My Te Kura.

MP1000

Music

NCEA Level 1 (course endorsement available)

This course builds skills in solo and group performance on an instrument or with voice. It also provides study of composition, music knowledge, aural perception, score reading and music technology (only in consultation with the senior teacher).

All students need their own instrument and access to a music mentor within their own community.

As a way of acknowledging students' strengths in broader performing arts disciplines, some Level 1 dance standards are also offered within this course.

Recommended prior learning: Students should have two or more years of music learning. To undertake the dance standards, students should have two or more years experience in dance or Māori performing arts or both.

This course is accessed through our online learning environment – My Te Kura.

Demonstrate and apply introductory knowledge of music technology equipment and techniques

US27656 Cr Internal 4 credits

Perform dance sequences

AS90002 Cr Internal 6 credits

Demonstrate ensemble skills in a dance

AS90859 Cr Internal 4 credits

Perform two pieces of music as a featured soloist

AS91090 Cr Internal 6 credits

Demonstrate ensemble skills through performing a piece of music as a member of a group

AS91091 Cr Internal 4 credits

Compose two original pieces of music

AS91092 Cr Internal 6 credits

Demonstrate aural and theoretical skills through transcription

AS91093 Cr External 4 credits

Demonstrate knowledge of conventions used in music scores

AS91094 (la) Cr External 4 credits

Demonstrate knowledge of two music works from contrasting contexts

AS91095 (la) Cr Internal 6 credits

MP2000

Music

NCEA Level 2 (course endorsement available)

This course continues to build skills in solo and group performance on an instrument or with voice. It also provides further study of composition, music knowledge, score reading and music technology (only in consultation with the senior teacher).

All students need their own instrument and access to a music mentor within their own community.

As a way of acknowledging students' strengths in broader performing arts disciplines, some Level 2 dance standards are also offered within this course.

Recommended prior learning: Students should have three or more years of music learning. To undertake the dance standards students should have completed Level 1 dance standards and have three or more years experience in either dance or Māori performing arts or both.

This course is accessed through our online learning environment – My Te Kura.

Demonstrate knowledge of the development and usage of music technology equipment and techniques

US27657 Cr Internal 4 credits

Demonstrate and apply knowledge of electronic music production and music notation application(s)

US27658 Cr Internal 4 credits

Perform an ethnic or social dance to communicate understanding of the style

AS91207 SCr Internal 4 credits

Perform a repertoire of dance

AS91209 SCr Internal 6 credits

Perform two substantial pieces of music as a featured soloist

AS91270 SCr Internal 6 credits

Compose two substantial pieces of music

AS91271 SCr Internal 6 credits

Demonstrate ensemble skills by performing a substantial piece of music as a member of a group

AS91272 SCr Internal 4 credits

Devise an instrumentation for an ensemble

AS91273 SCr Internal 4 credits

Perform a substantial piece of music as a featured soloist on a second instrument

AS91274 SCr Internal 3 credits

Demonstrate knowledge of conventions in a range of music scores

AS91276 (la) Cr External 4 credits

Investigate an aspect of New Zealand music

AS91278 (la) SCr Internal 4 credits

MP3000

Music

NCEA Level 3 (course endorsement available)

This course focuses on extending practical music making including composition, arranging and music technology as well as providing topics to increase musical literacy and music research skills.

Students need their own instrument and access to a music mentor within their own community.

New Zealand Scholarship exams are designed to extend very high achieving Level 3 students. Those who wish to enter the New Zealand Scholarship exam in this subject must discuss this option with their Te Kura subject teacher.

Recommended prior learning: Students should have four or more years of music learning.

This course is accessed through our online learning environment – My Te Kura.

Operate music sequencing, editing, and music notation application(s)

US23730 Internal 8 credits

Perform two programmes of music as a featured soloist

AS91416 Internal 8 credits

Perform a programme of music as a featured soloist on a second instrument

AS91417 Internal 4 credits

Demonstrate ensemble skills by performing two substantial pieces of music as a member of a group

AS91418 Internal 4 credits

Communicate musical intention by composing three original pieces of music

AS91419 Internal 8 credits

Demonstrate understanding of harmonic and tonal conventions in a range of music scores

AS91421 External 4 credits

Create two arrangements for an ensemble

AS91424 Internal 4 credits

Research a music topic

AS91425 (la) UEIra Internal 6 credits

Compose three original songs that express imaginative thinking

AS91849 Internal 8 credits

Pathways Education

Te Mātauranga Rapuara

Pathways Education provides learning opportunities to develop the foundation skills required to move successfully between school and work, be prepared for further education and move into paid employment or work in the voluntary sector.

PW1000

Pathways Education

NCEA Level I

Pathways Education helps students develop the skills and knowledge for the workplace. The course is made up of three modules.

Students start on the first module **PW1001** and then choose any of the other modules.

Recommended prior learning: Students should have a reasonable level of literacy.

This course is accessed through our online learning environment – My Te Kura.

PW1001 Getting Ready for Work

Demonstrate knowledge of workplace health and safety requirements

US497 Internal 3 credits

Produce a CV (curriculum vitae)

US504 Internal 2 credits

Describe basic employment rights and responsibilities, and sources of information and/or assistance

US1978 Internal 3 credits

Complete an incident report

US3490 Internal 2 credits

Describe requirements and expectations faced by employees within the workplace

US4248 Internal 3 credits

Describe obligations as an employee

US4249 Internal 3 credits

PW1002 Self-Management Skills

Produce, implement, and reflect on a plan to improve own personal wellbeing

US496 So Cr Internal 3 credits

Describe community agencies and services provided

US526 So Internal 2 credits

Demonstrate knowledge of anger management

US12348 Pr So Cr Internal 2 credits

Interpret and confirm accuracy of financial documents for personal financial capability

US24705 So Cr Internal 2 credits

Produce a balanced budget to manage personal finances

US24709 Pr So Cr Internal 3 credits

PW1003 Skills for the workplace

Please note this module is easier for students who have or have had a work placement. This can be voluntary work, a part-time job, work experience or a Gateway placement.

Perform calculations for a specified workplace

US64 Ma Pr Se So Internal 2 credits

Recognise discrimination and describe ways of responding

US542 Pr So Internal 3 credits

Be interviewed in an informal, one-to-one, face-to-face interview

US1293 Ma Pr So Cr Internal 2 credits

Fill in a form

US3483 Pr So Cr Internal 2 credits

Participate and communicate in a team or group to complete a routine task

US3503 Pr So Cr Internal 2 credits

Perform income-related calculations for personal financial capability

US24697 So Cr Internal 2 credits

PW2000**Pathways Education**

NCEA Level 2

Pathways Education helps students develop the skills and knowledge for the workplace. The course offers six modules.

Students will begin in the first module Getting Ready for Work (PW2001) and then choose any three of the other modules.

Please note that students may need a work placement for some standards. This can be voluntary work, a part time job, work experience or a Gateway placement.

Recommended prior learning: Students should have a reasonable level of literacy.

This course is accessed through our online learning environment – My Te Kura.

PW2001 Getting Ready for Work

Pathways Education helps students develop the skills and knowledge for the workplace.

Demonstrate knowledge of diversity in workplaces

US377 Pr SSe SSo Cr Internal 2 credits

Describe employment agreements

US1979 Cr Internal 3 credits

Produce a personal targeted CV (curriculum vitae)

US4252 Pr So Cr Internal 2 credits

Develop strategies to enhance own learning

US7117 So Cr Internal 2 credits

Apply a problem-solving method

US7123 Pr So Cr Internal 3 credits

Demonstrate knowledge of time management

US12349 Internal 3 credits

PW2002 Work Skills

Pathways Education helps students develop the skills and knowledge for the workplace.

Maintain personal presentation and a positive attitude in a workplace involving customer contact

US62 Cr Pi Sc Si Internal 3 credits

Be interviewed in a formal interview

US1294 Pr So Cr Internal 2 credits

Identify support services and resources within the community

US1827 SSo Cr Internal 2 credits

Complete a work experience placement

US10780 Pr So Internal 3 credits

Complete complex forms

US24871 Internal 2 credits

PW2003 Future Planning

Demonstrate knowledge of job search skills

US4253 Pr So Cr Internal 3 credits

Produce a plan for own future directions

US10781 Pr Cr Internal 3 credits

Describe legal implications of living in rented accommodation and means to prevent and resolve related problems

US12354 Cr Internal 4 credits

Explore career options and their implications

US12383 Cr Pi Internal 3 credits

Make an informed decision relating to personal income and explain its impacts

US24699 Pr Se Cr Internal 2 credits

PW2004 Early Childhood

This module is based on early childhood education and is useful for students wanting to gain skills in this area.

It offers 16 credits on the social and community skills vocational pathways and 10 of these are sector-related standards.

Demonstrate knowledge of diversity in workplaces

US377 Internal 2 credits

Be assertive in a range of specified situations

US1299 Pr So Cr Internal 4 credits

Identify support services and resources within the community

US1827 SSo Cr Internal 2 credits

Describe the basic needs of children in an ECE service

US10021 Sc Internal 3 credits

Demonstrate knowledge of promoting the health and wellbeing of children in an ECE service

US10024 Sc Internal 3 credits

Complete complex forms

US24871 Internal 2 credits

PW2005 Customer Service

This module is based on customer service and offers 12 credits from the service sector vocational pathway. All of these are sector-related standards.

Provide customer service

US57 Cr Pi Sc Si Internal 2 credits

Maintain personal presentation and a positive attitude in a workplace involving customer contact

US62 Cr Pi Sc Si Internal 3 credits

Demonstrate and apply knowledge of office equipment and administration processes

US121 Internal 5 credits

Demonstrate knowledge of diversity in workplaces

US377 Pr SSe SSo Cr Internal 2 credits

PW2007 Automotive Skills

Pathways Education helps students develop skills and knowledge of traffic law as well as time management.

Demonstrate knowledge of traffic law for the purpose of safe driving

US3462 Co Pr Cr Internal 3 credits

Demonstrate knowledge of time management

US12349 Co Ma Pr So Cr Internal 3 credits

PCI000

Pregnancy and Childcare

NCEA Level I

This course provides information on pregnancy, positive parenting techniques and early childhood development. It gives students the opportunity to practise food preparation skills, make and investigate the safety of toys and observe child behaviour. Students also investigate local facilities and services available.

Recommended prior learning: Students should have a reasonable level of literacy.

This course is accessed through our online learning environment – My Te Kura.

Produce, implement, and reflect on a plan to improve own personal wellbeing

US496 Internal 3 credits

Performing Arts

Ngā mahi ā te Rēhia

Performing Arts explores challenges and celebrates practical expressions of self and culture. Students have the opportunity to develop their practical performing arts skills, which can foster their creative and critical abilities as well as enjoyment of performance.

PA1000

Performing Arts

NCEA Levels 1 & 2

This programme offers opportunities in solo and group dance performance with the additional possibility of group music performance.

A range of Level 1 and Level 2 standards is offered and students should complete Level 1 standards in their chosen speciality before undertaking Level 2 standards.

In consultation with the dance teacher, some Level 3 standards may be offered to students who have completed the Level 2 standards.

The assessment focus is on individual performance, captured with quality video recording within solo or group contexts.

Recommended prior learning: Two years or more experience is required in one or more of dance, Māori performing arts or music.

This course is accessed through our online learning environment – My Te Kura. It includes a mix of interactive online modules and downloadable resources in PDF format.

Perform a solo or duet dance

AS91590 SCr Internal 4 credits

Perform a group dance

AS91591 SCr Internal 4 credits

Perform dance sequences

AS90002 Cr Internal 6 credits

Demonstrate ensemble skills in a dance

AS90859 Cr Internal 4 credits

Demonstrate ensemble skills through performing a piece of music as a member of a group

AS91091 Cr Internal 4 credits

Perform an ethnic or social dance to communicate understanding of the style

AS91207 SCr Internal 4 credits

Perform a repertoire of dance

AS91209 SCr Internal 6 credits

Demonstrate ensemble skills by performing a substantial piece of music as a member of a group

AS91272 SCr Internal 4 credits

Physical Education

Mātauranga Hākinakina

In Physical Education students consider physical performances and factors that affect these performances and also work towards promoting physical activity in their communities. Students have the opportunity to engage in a variety of physical activities as well as explore the body systems, training programmes and how to improve performances for themselves and others.

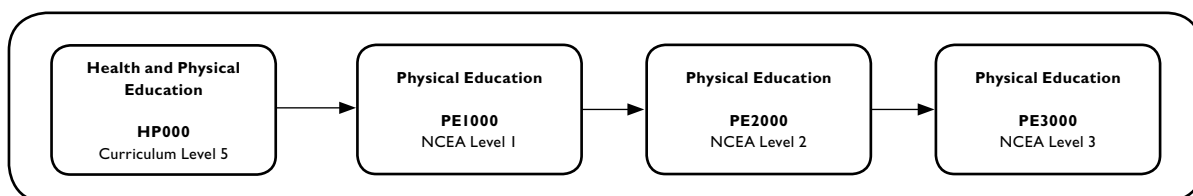

HP000

Health and Physical Education

Curriculum Level 5

In this course students explore health issues such as wellbeing, nutrition, communication, decision making, problem solving, safety issues around drug use, and understanding gender and sexuality. Students will also study Physical Education topics such as understanding the body, fitness testing, participating in a variety of activities, and being involved in training programmes.

Recommended prior learning: No prior learning needed.

This course is accessed through our online learning environment – My Te Kura.

PE1000

Physical Education

NCEA Level 1 (course endorsement available)

This course follows on from Health and Physical Education (HP000). In Physical Education, students study anatomy and physiology, practical performances and influences that affect participation in physical activity.

The Physical Education topics offer 19 credits towards NCEA Level 1. There are 5 internal standards and no external standards. Physical Education topics offer 11 Literacy credits.

To gain course endorsement students need to complete 14 credits in Physical Education.

Recommended prior learning: No prior learning needed.

This course is accessed through our online learning environment – My Te Kura.

Participate actively in a variety of physical activities and explain factors that influence own participation

AS90962 Se So Cr Internal 5 credits

Demonstrate understanding of the function of the body as it relates to the performance of physical activity

AS90963 (1a) Pr Se So Cr Internal 5 credits

Demonstrate quality movement in the performance of a physical activity

AS90964 Se So Cr Internal 3 credits

Demonstrate strategies to improve the performance of a physical activity and describe the outcomes

AS90967 (1a) Se So Cr Internal 3 credits

Take action to enhance an aspect of personal well-being

AS90971 (1a) Pr Se So Cr Internal 3 credits

PE2000**Physical Education**

NCEA Level 2 (course endorsement available)

This course follows on from Physical Education – NCEA Level 1 (PE1000) and is useful and often essential for students intending to continue with Level 3 Physical Education courses.

The Physical Education topics include biophysical principles, practical performances, influences of a training programme, and examining the impact of a sport on society.

The Physical Education topics offer 17 credits towards NCEA Level 2. There are 4 internal standards and no external standards. Physical Education topics also offer 13 Literacy credits.

To gain course endorsement students need to complete 14 credits in Physical Education.

Recommended prior learning: NCEA Level 1 PE or equivalent.

This course is accessed through our online learning environment – My Te Kura.

Demonstrate understanding of how and why biophysical principles relate to the learning of physical skills

AS91328 (la) SSe So Cr Internal 5 credits

Demonstrate understanding of the application of biophysical principles to training for physical activity

AS91329 (la) SSe SCr Internal 4 credits

Perform a physical activity in an applied setting

AS91330 Se Cr Internal 4 credits

Examine the significance for self, others and society of a sporting event, a physical activity, or a festival

AS91331 (la) Se So Cr Internal 4 credits

PE3000**Physical Education**

NCEA Level 3 (course endorsement available)

This course follows on from Physical Education – NCEA Level 2 (PE2000) and is often essential for students intending to continue with Physical Education courses at tertiary institutions.

Physical Education students have the opportunity to study topics on analysing an activity, practical performances, evaluating a training programme, evaluating safety management and examining an issue in society.

The Physical Education topics offer 18 credits towards NCEA Level 3. There are 5 internal standards worth 18 credits and no external standards. These Physical Education topics also offer 14 Literacy credits and 4 Numeracy credits.

To gain course endorsement or entry to a tertiary institution you will need to complete 14 credits in Physical Education.

Recommended prior learning: NCEA Level 2 Physical Education or equivalent.

This course is accessed through our online learning environment – My Te Kura.

Analyse a physical skill performed by self or others

AS91499 (la) Internal 3 credits

Evaluate the effectiveness of a performance improvement programme

AS91500 (lna) UEna Internal 4 credits

Demonstrate quality performance of a physical activity in an applied setting

AS91501 (na) UEna Internal 4 credits

Examine a current physical activity event, trend, or issue and its impact on New Zealand society

AS91502 (la) UEIra Internal 4 credits

Analyse issues in safety management for outdoor activity to devise safety management strategies

AS91504 (la) Internal 3 credits

Physics

Te Mātauranga Ahupūngao

Physics is the study of the matter and energy that makes up the physical world. It offers an insight into the fundamental ways the world works scientifically and its relationship with technology. This includes topics such as light, sound, heat, movement, forces, atomic physics as well as electricity and magnetism. Students encounter many key scientific ideas and concepts that support study in other science subjects and related areas such as engineering and health science.

PH1000

Physics

NCEA Level 1 (course endorsements available)

This is an introductory course into the study of Physics, which features the main themes of heat, electricity and waves. Over the duration of the course, students gain an understanding of the basic concepts in Physics.

This course offers three external standards and two internal standards. Students who wish to study Physics at Level 2 must include at least one externally assessed standard from the list below or the Mechanics standard AS90940, which is offered in Science – NCEA Level 1 (SC1000).

Science – NCEA Level 1 (SC1000) also offers three standards, AS90941, AS90942 and AS90943. These standards will not lead to Level 2 Physics.

Recommended prior learning: Students should have a reasonable level of literacy and numeracy.

This course is accessed through our online learning environment – My Te Kura.

Carry out a practical physics investigation that leads to a linear mathematical relationship, with direction

AS90935 (na) UEna Co Ma Pr So Cr Internal 4 credits

Demonstrate understanding of the physics of an application

AS90936 (la) Co Ma Pr So Cr Internal 2 credits

Demonstrate understanding of aspects of electricity and magnetism

AS90937 (na) UEna Co Ma Cr External 4 credits

Demonstrate understanding of aspects of wave behaviour

AS90938 (na) UEna Co Ma Cr External 4 credits

Demonstrate understanding of aspects of heat

AS90939 (na) UEna Co Ma Pr Cr External 4 credits

Demonstrate understanding of aspects of mechanics

AS90940 (na) UEna Co Ma Pr Se So Cr External 4 credits

PH2000

Physics

NCEA Level 2 (course endorsement available)

This course is for students interested in studying sciences, engineering, medicine, veterinary science and for those who are interested in careers as pilots, medical laboratory assistants and electricians.

The main themes of the course are mechanics, waves, electricity and atomic and nuclear physics. It is suitable for students who have successfully studied some physics and mathematics at NCEA Level 1.

This course offers 26 credits of which 16 are externally assessed by NCEA examination in November.

Recommended prior learning: NCEA Level 1 Physics or equivalent.

This course is accessed through our online learning environment – My Te Kura.

Carry out a practical physics investigation that leads to a nonlinear mathematical relationship

AS91168 (Ina) UEna Co Ma Pr So Cr Internal 4 credits

Demonstrate understanding of physics relevant to a selected context

AS91169 (la) Ci Cr Mt Pi Sc Internal 3 credits

Demonstrate understanding of waves

AS91170 (Ina) UEna Co Ma Pr So Cr External 4 credits

Demonstrate understanding of mechanics

AS91171 (Ina) UEna Co Ma Pr So Cr External 6 credits

Demonstrate understanding of atomic and nuclear physics

AS91172 (la) Co Ma So Cr Internal 3 credits

Demonstrate understanding of electricity and electromagnetism

AS91173 (Ina) UEna Co Ma Pr So Cr External 6 credits

PH3000**Physics**

NCEA Level 3 (course endorsement available)

This course is designed for students interested in studying sciences, engineering, medicine or veterinary science at tertiary level and other physics-related technical studies at diploma level.

The main themes of the course are mechanics, waves, electricity and modern physics. It builds on the theory already covered in Level 2 Physics, so it is essential that students who intend to study this course have successfully completed NCEA Level 2 Physics and have studied trigonometry, algebra and graphing in Level 2 mathematics.

This course offers 29 credits of which 16 are externally assessed by NCEA examination in November.

Recommended prior learning: NCEA Level 2 Physics or equivalent. Students with limited prerequisites are advised to contact a physics teacher to discuss their programme.

This is an online course available through our online learning environment, My Te Kura.

Carry out a practical investigation to test a physics theory relating two variables in a nonlinear relationship

AS91521 (la) Internal 4 credits

Demonstrate understanding of the application of physics to a selected context

AS91522 (la) Internal 3 credits

Demonstrate understanding of wave systems

AS91523 (la) External 4 credits

Demonstrate understanding of mechanical systems

AS91524 (la) External 6 credits

Demonstrate understanding of Modern Physics

AS91525 (la) Internal 3 credits

Demonstrate understanding of electrical systems

AS91526 (la) External 6 credits

Use physics knowledge to develop an informed response to a socio-scientific issue

AS91527 (la) UEIra Internal 3 credits

Primary Production (Agriculture/Horticulture)

Te Ahumahi Matua

Agriculture and horticulture are two main parts of New Zealand's primary industry sector. Primary industries form the backbone for many New Zealand communities and are the country's biggest export earner. Primary Production is about producing living things from the land and water. This includes producing and rearing large livestock, such as cattle, sheep, pigs and deer, or smaller animals such as poultry, bees and earthworms. Aquatic animals such as fish and shellfish are farmed in New Zealand fresh and salt waters. Plants are grown in large-scale forests, plantations, vineyards and fields or in smaller scale market gardens. Plants are also grown for pleasure in ornamental gardens, turf culture and in landscape design.

Knowing the principles of producing and selling these primary products using methods that care for our environment gives students a huge range of career choices. Possibilities range from 'hands-on' production to science, business, marketing, law and finance-related roles. All Primary Production courses link well with subjects such as science, biology, geography and economics.

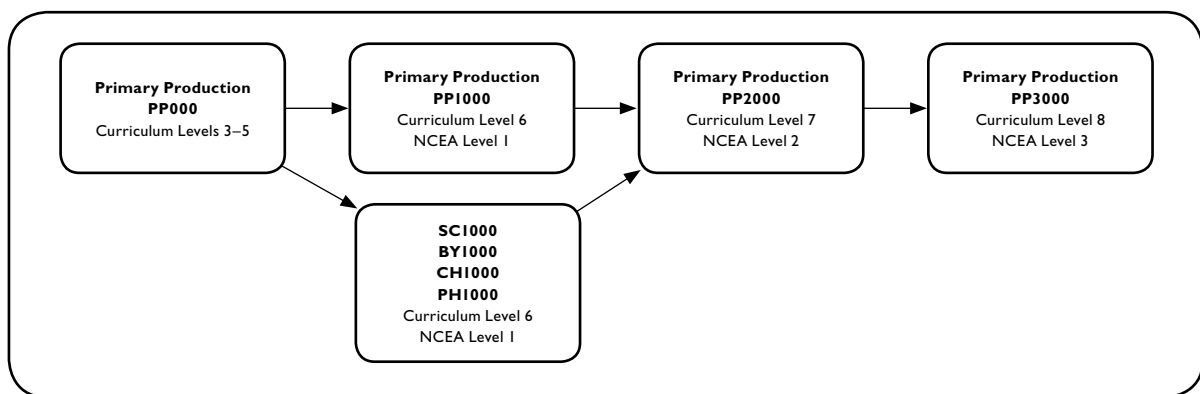

PP000

Introduction to Primary Production

Curriculum Levels 3–5

These Primary Production modules provide a basic introduction to agriculture and horticulture. There are agriculture modules about the farming of sheep, dairy cattle and pigs as well as forestry, bee keeping and aspects of farm safety. In the horticulture modules students learn about the biological make-up of plants, what plants need to survive to produce high yields, the make-up of soil and soil communities, principles of garden design and care of the environment. From the range of Primary Production modules offered, students can select a programme to suit their interests. This could be a traditional agriculture or horticulture course, or a mixture of modules from both. This course provides a foundation for progression on to Level 1 standards in agricultural and horticultural science.

Recommended prior learning: No prior learning needed.

This course is accessed through our online learning environment – My Te Kura.

PP1000

Primary Production

Agricultural and Horticultural Science
NCEA Level 1 (course endorsement available)

As an introduction to Primary Production, this course covers the commercial production aspects of the agriculture and horticulture industries in New Zealand.

The agriculture standards look at the care and production of farm animals, pasture and crops. Students develop the fundamental knowledge needed to manage livestock, pasture, farm equipment and soils.

The horticulture standards cover a variety of general horticultural topics including plant propagation and landscaping.

Students can select only agriculture standards or horticulture standards or a combination of both that will fit their interests and needs. Within some standards, students can choose between an agricultural or horticultural perspective. The overall focus is on the New Zealand primary production industries, what is involved in maximising production of producing primary products and the associated environmental issues.

Recommended prior learning: Students should have a reasonable level of literacy.

This course is accessed through our online learning environment – My Te Kura.

Demonstrate knowledge of pasture/crop management practices

AS90155 (la) Pr Internal 4 credits

Demonstrate practical skills used in agricultural or horticultural production

AS90157 Pr Internal 4 credits

Demonstrate knowledge of the impact on the environment of primary production management practices

AS90160 (la) Pr Internal 3 credits

Carry out a practical agricultural or horticultural investigation

AS90918 (na) UEna Pr Internal 4 credits

Demonstrate knowledge of soil management practices

AS90919 (la) Pr External 4 credits

Demonstrate knowledge of the geographic distribution of agricultural and horticultural primary production in New Zealand

AS90920 (la) Pr Internal 3 credits

Demonstrate knowledge of livestock management practices

AS90921 (la) Pr External 5 credits

Design a landscape plan that reflects user requirements

AS90922 Pr Internal 3 credits

Demonstrate knowledge of basic plant propagation techniques

AS90923 (la) Pr Internal 4 credits

Demonstrate knowledge of horticultural plant management practices and related plant physiology

AS90924 (la) Pr External 5 credits

PP2000

Primary Production

Agricultural and Horticultural Science
NCEA Level 2 (course endorsement available)

This primary production course covers Level 2 agriculture and horticulture achievement standards.

Agriculture topics include livestock topics related to reproductive technologies, livestock behaviour and livestock growth and development.

Horticulture topics include plant propagation, plant management practices, landscaping and a practical investigation.

Students can select only agriculture standards or horticulture standards or a combination of both that will fit their interests and needs.

During this course, students learn how to describe and analyse the physical, environmental and biological factors that affect primary production. There are some standards where students can choose between an agricultural or horticultural perspective.

Recommended prior learning: Students should have a reasonable level of literacy.

This course is accessed through our online learning environment – My Te Kura.

Carry out an extended practical agricultural or horticultural investigation

AS91289 (na) UEna Pr Internal 4 credits

Demonstrate understanding of techniques used to modify physical factors of the environment for NZ plant production

AS91290 (la) Pr External 4 credits

Demonstrate understanding of advanced plant propagation techniques used for commercial production in New Zealand

AS91291 (la) Pr Internal 4 credits

Demonstrate understanding of how management practices influence plant growth and development in NZ commercial production

AS91292 (la) Pr Internal 4 credits

Demonstrate understanding of livestock reproductive techniques in commercial production in New Zealand

AS91293 (la) Pr Internal 4 credits

Demonstrate understanding of how NZ commercial management practices influence livestock growth and development

AS91294 (la) Pr External 4 credits

Demonstrate understanding of interactions between livestock behaviour and NZ commercial management practices

AS91295 (la) Pr Internal 4 credits

Produce a landscape plan

AS91296 (la) Pr Co Internal 4 credits

Report on the environmental impact of the production of a locally produced primary product

AS91298 (la) Pr Internal 4 credits

PP3000**Primary Production**

Agricultural and Horticultural Science
NCEA Level 3 (course endorsement available)

This combined agriculture and horticulture course will appeal to students with an interest in commercial production of primary products and their marketing to maximise profits. Based on the production process, students are given an insight into New Zealand's agricultural and horticultural exports, with a particular focus on lamb meat and apple crop production.

Other standards provide students with the option of investigating other primary products of their choice and the environmental factors associated. The course links well with subjects such as science, biology, geography and economics.

Recommended prior learning: Students should have a reasonable level of literacy and have studied achievement standards in agriculture or horticulture.

This course is accessed through our online learning environment – My Te Kura.

Carry out an investigation into an aspect of a New Zealand primary product or its production

AS91528 (1na) UEna Pr Internal 4 credits

Research and report on the impact of factors on the profitability of a New Zealand primary product

AS91529 (1na) UEnra Pr Internal 6 credits

Demonstrate understanding of how market forces affect supply of and demand for New Zealand primary products

AS91530 (1na) UEnrwa Pr External 5 credits

Demonstrate understanding of how the production process meets market requirements for a New Zealand primary product(s)

AS91531 (1a) Pr External 4 credits

Analyse a New Zealand primary production environmental issue

AS91532 (1a) Pr External 5 credits

Samoan

Te Reo Hāmoa

Samoan Language (Gagana Sāmoa) is spoken by nearly half a million people worldwide, including 85 thousand people in New Zealand, making it the third most widely spoken language in New Zealand (after English and te reo Māori). Whether students are learning Samoan to strengthen their identity as Samoan, to communicate with family members, for career enhancement or another reason, this subject will provide them with an opportunity to build on prior learning and to develop problem-solving, risk-taking and communication skills.

SA1000

Samoan

NCEA Level 1 (course endorsement available)

This Samoan course helps students develop their reading, writing, listening and speaking skills through a range of topics such as family, home life and, celebrations. The course is structured to allow flexibility in terms of the order in which topics are studied and also includes an open-ended topic that enables students to investigate an area of their own interest.

Recommended prior learning: Students must have completed Year 10 Samoan or equivalent or have a Samoan language background.

This course is accessed through our online learning environment – My Te Kura.

Students will be required to make and submit audio and/or video recordings, so a microphone and camera or mobile device are required.

Demonstrate understanding of a variety of spoken Samoan texts on areas of most immediate relevance

AS90903 Pr Se So SCr External 5 credits

Give a spoken presentation in Samoan that communicates a personal response

AS90904 Pr Internal 4 credits

Interact using spoken Samoan to communicate personal information, ideas and opinions in different situations

AS90905 Se So Cr Internal 5 credits

Demonstrate understanding of a variety of Samoan texts on areas of most immediate relevance

AS90906 Se External 5 credits

Write a variety of text types in Samoan on areas of most immediate relevance

AS90907 Se Cr Internal 5 credits

Science

Te Mātauranga Pūtaiao

Science is a discipline that provides students with a range of skills and ways of thinking that are valuable in many aspects of life and work. Have you thought about why you need to eat, why cars rust, how batteries produce electrical energy or why clouds produce rain? Science helps students discover answers to such questions. Students explore not just the world of living things, but all types of substances and how they react while gaining an understanding of concepts such as force and energy that affect the Earth and space. Many issues that confront us today, such as environmental concerns, energy use, manufacturer product claims, growing our own food, maintaining good health and raising children, have scientific aspects. Many choices we make in life have a scientific perspective. This subject is not just learning about science, but understanding how to make sense of scientific information we are bombarded with on a daily basis.

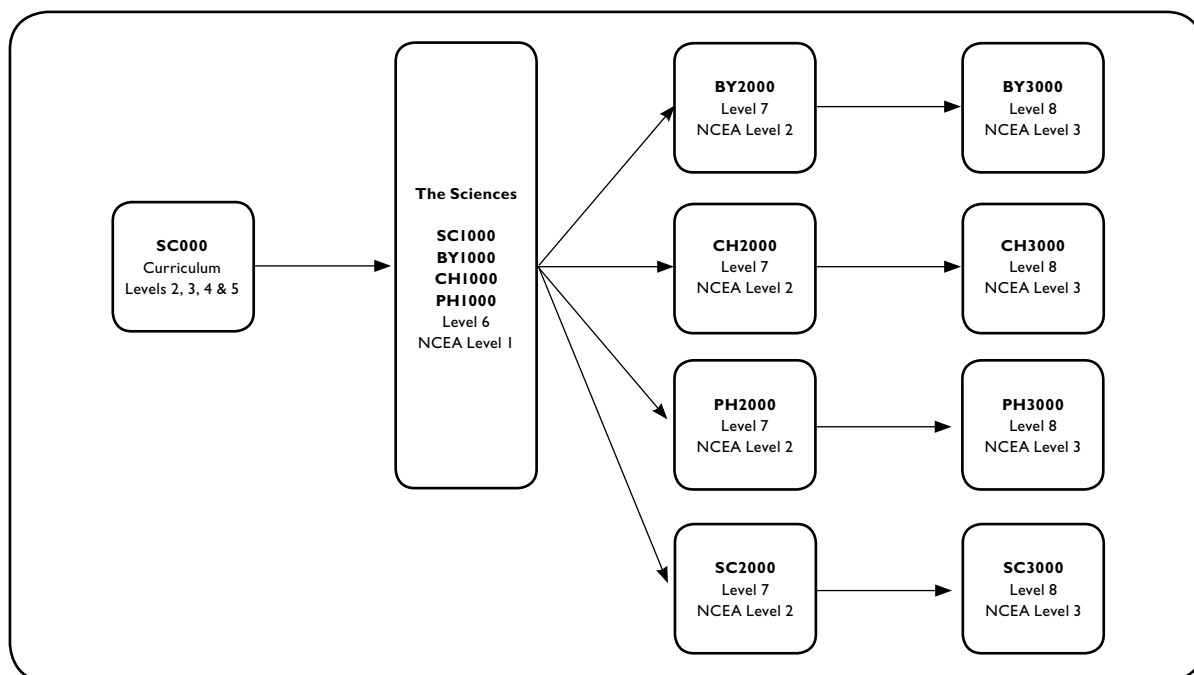

SC000

Introducing Science

Curriculum Levels 2–5

This course is aimed at students in Year 9 and above who are studying at Curriculum Levels 2–5. It offers a flexible programme with a wide variety of topics that help students build skills and understanding. By studying the living world, the material world (chemistry), the physical world, Earth and beyond, students learn about the nature of science, what science is and how scientists work. Some of the current topics are space, electrical circuits, forces, acids and bases and how the body works.

The course includes hands-on experimental work, online activities and research investigations. Students can progress through this course, year by year, up to Curriculum Level 5. When they have studied a range of topics at Curriculum Level 5, they will be well-prepared for NCEA study of the sciences.

Recommended prior learning: No prior learning needed.

This course is accessed through our online learning environment – My Te Kura.

SCI000**Science**

NCEA Level 1 (course endorsement available)

This course offers a broad selection of standards in Science at Level 1. In one year, students normally study for around five standards offering 18–20 credits from a choice of 16 possible achievement standards.

The wide range of standards allows a student to study different aspects of science. Students' selection of science topics and standards are based on their interests and goals. For example, students with an interest in medical science can choose standards in genetics, microbes, acids and bases, life processes and the implications of burning carbon-based fuels.

Advice is available from Te Kura science teachers. Teachers help to select the right standards to ensure students study an appropriate range of standards that involve the physical world, the material world, the living world, Earth and beyond.

Students are encouraged to contact their teacher soon after enrolment to discuss topic choices and whether they prefer to complete work that is only internally assessed or assessed by both internal and external assessment.

Students committed to a science-related career should consider choosing an additional NCEA Level 1 specialist science course. The course includes hands-on experimental work, computer-based activities and research investigations. It provides a good preparation for study of the sciences at Level 2.

Recommended prior learning: Students should have a reasonable level of literacy and numeracy.

This course is accessed through our online learning environment – My Te Kura.

Carry out a practical investigation in a biological context, with direction

AS90925 Ma Pr Se So Internal 4 credits

Carry out a practical chemistry investigation, with direction

AS90930 Co Ma Pr Se Cr Internal 4 credits

Demonstrate understanding of the chemistry in a technological application

AS90931 Co Ma Pr Se Cr Internal 2 credits

Demonstrate understanding of aspects of mechanics

AS90940 (na) UEna Co Ma Pr Se So Cr External 4 credits

Investigate implications of electricity and magnetism for everyday life

AS90941 (na) UEna Co Ma Pr Cr Internal 4 credits

Investigate implications of wave behaviour for everyday life

AS90942 (na) UEna Ma Pr Cr Internal 4 credits

Investigate implications of heat for everyday life

AS90943 (na) UEna Co Ma Pr So Cr Internal 4 credits

Demonstrate understanding of aspects of acids and bases

AS90944 Co Ma Pr Cr External 4 credits

Investigate implications of the use of carbon compounds as fuels

AS90945 Co Ma Pr Se So Cr Internal 4 credits

Investigate the implications of the properties of metals for their use in society

AS90946 Co Ma Pr Cr Internal 4 credits

Investigate selected chemical reactions

AS90947 Co Ma Pr So Cr Internal 4 credits

Demonstrate understanding of biological ideas relating to genetic variation

AS90948 (la) Ma Pr So Cr External 4 credits

Investigate life processes and environmental factors that affect them

AS90949 Pr Se So Cr Internal 4 credits

Investigate biological ideas relating to interactions between humans and micro-organisms

AS90950 Co Ma Pr Se So Cr Internal 4 credits

Investigate the biological impact of an event on a New Zealand ecosystem

AS90951 Pr Se Cr Internal 4 credits

Investigate an astronomical or Earth science event

AS90955 (la) Pr So Cr Internal 4 credits

SC2000**Science****NCEA Level 2 (course endorsement available)**

This course is available to students who want a general science course at Level 2 that can be done along with Social Sciences, Arts, English, Health and PE or Technology.

Science offers valuable skills and ways of thinking that help students become informed about the world and are beneficial to those who are considering careers in a range of different industries.

Recommended prior learning: Recommended prior learning is Level 1 in a Science subject.

This course offers a maximum of 16 credits and should not be done with BY2000, CH2000 or PH2000 due to the overlap of standards.

This course is accessed through our online learning environment – My Te Kura.

Carry out a practical investigation in a biology context, with supervision

AS91153 (na) UEna Mt Pi Sc Si Internal 4 credits

Analyse the biological validity of information presented to the public

AS91154 (la) Pr So Internal 3 credits

Demonstrate understanding of adaptation of plants or animals to their way of life

AS91155 (la) Pr Se So Internal 3 credits

Demonstrate understanding of life processes at the cellular level

AS91156 (la) Pr So External 4 credits

Demonstrate understanding of genetic variation and change

AS91157 (la) Pr So External 4 credits

Investigate a pattern in an ecological community, with supervision

AS91158 (la) Pr Internal 4 credits

Demonstrate understanding of gene expression

AS91159 (la) Pr So External 4 credits

Carry out quantitative analysis

AS91161 (na) UEna Co Ma Pr So Cr Internal 4 credits

Demonstrate understanding of the chemistry used in the development of a current technology

AS91163 (la) Co Ma Pr Se So Cr Internal 3 credits

Demonstrate understanding of bonding, structure, properties and energy changes

AS91164 (la) Co Ma Pr So Cr External 5 credits

Demonstrate understanding of the properties of selected organic compounds

AS91165 (la) Co Ma Pr Se So Cr External 4 credits

Demonstrate understanding of chemical reactivity

AS91166 (la) Co Ma Pr Se So Cr External 4 credits

Demonstrate understanding of oxidation-reduction

AS91167 Co Ma Pr So Cr Internal 3 credits

Carry out a practical physics investigation that leads to a nonlinear mathematical relationship

AS91168 (lna) UEna Co Ma Pr So Cr Internal 4 credits

Demonstrate understanding of physics relevant to a selected context

AS91169 (la) Co Ma Pr So Cr Internal 3 credits

Demonstrate understanding of waves

AS91170 (lna) UEna Co Ma Pr So Cr External 4 credits

Demonstrate understanding of mechanics

AS91171 (lna) UEna Co Ma Pr So Cr External 6 credits

Demonstrate understanding of atomic and nuclear physics

AS91172 (la) Co Ma So Cr Internal 3 credits

Demonstrate understanding of electricity and electromagnetism

AS91173 (lna) UEna Co Ma Pr So Cr External 6 credits

Carry out an extended practical agricultural or horticultural investigation

AS91289 (na) Pr Internal 4 credits

Demonstrate understanding of advanced plant propagation techniques used for commercial production in New Zealand

AS91291 (la) Pr Internal 4 credits

Report on the environmental impact of the production of a locally produced primary product

AS91298 (la) Pr Internal 4 credits

SC3000**Science**

NCEA Level 3 (course endorsement available)

This course is available to students who want a general science course at Level 3 that can be done along with Social Sciences, Arts, English, Health and PE or Technology.

Science at this level offers valuable skills and ways of thinking that help students become informed about the world and are beneficial to those who are considering careers in a range of different industries.

Recommended prior learning: Recommended prior learning is Level 2 in a Science subject.

This course offers a maximum of 16 credits and should not be done with BY3000, CH3000 or PH3000 due to the overlap of standards.

This course is accessed through our online learning environment – My Te Kura.

Demonstrate understanding of spectroscopic data in chemistry

AS91388 Internal 3 credits

Demonstrate understanding of chemical processes in the world around us

AS91389 (la) UElwra Internal 3 credits

Demonstrate understanding of thermochemical principles and the properties of particles and substances

AS91390 (la) External 5 credits

Demonstrate understanding of the properties of organic compounds

AS91391 (la) External 5 credits

Demonstrate understanding of equilibrium principles in aqueous systems

AS91392 (lna) UEna External 5 credits

Demonstrate understanding of oxidation-reduction processes

AS91393 (la) Internal 3 credits

Carry out a practical investigation to test a physics theory relating two variables in a nonlinear relationship

AS91521 (la) Internal 4 credits

Demonstrate understanding of the application of physics to a selected context

AS91522 (la) Internal 3 credits

Demonstrate understanding of wave systems

AS91523 (la) External 4 credits

Demonstrate understanding of mechanical systems

AS91524 (la) External 6 credits

Demonstrate understanding of Modern Physics

AS91525 (la) Internal 3 credits

Demonstrate understanding of electrical systems

AS91526 (la) External 6 credits

Use physics knowledge to develop an informed response to a socio-scientific issue

AS91527 (la) UElra Internal 3 credits

Carry out a practical investigation in a biological context, with guidance

AS91601 (lna) UEna Internal 4 credits

Integrate biological knowledge to develop an informed response to a socio-scientific issue

AS91602 (la) UElwra Internal 3 credits

Demonstrate understanding of the responses of plants and animals to their external environment

AS91603 (la) UElwra External 5 credits

Demonstrate understanding of how an animal maintains a stable internal environment

AS91604 (la) UElra Internal 3 credits

Demonstrate understanding of evolutionary processes leading to speciation

AS91605 (la) UElwra External 4 credits

Demonstrate understanding of trends in human evolution

AS91606 (la) UElwra External 4 credits

Demonstrate understanding of human manipulations of genetic transfer and its biological implications

AS91607 (la) UElra Internal 3 credits

Social Studies

Te Akoranga Tikanga ā-iwi

In Social Studies, students learn about people, places, cultures, histories and the economic world within and beyond New Zealand. Social Studies helps students understand people by exploring different points of view and beliefs. Students are given opportunities to develop communication, critical thinking and decision-making skills. These attributes help students become responsible and informed individuals with the ability to analyse the world that surrounds them. The course for each student is developed in consultation with the teacher to meet their particular needs and interests.

SS000

Social Studies

Curriculum Levels 3–5

In this course, students investigate issues in society and the interactions between cultures both within New Zealand and globally. Topics have a past, present and future focus.

The course is based around five overarching themes: connections, accessibility, organisation, survival and movement. Within these themes, students study topics such as sustainability, human rights, cultural diversity and enterprise. Students investigate how change affects New Zealand cultures, societies and communities, which helps them understand the past and the present and to imagine possible futures.

Students are encouraged to explore their own ideas about issues of concern to themselves, New Zealand or global communities.

Recommended prior learning: No prior learning needed.

This course is accessed through our online learning environment – My Te Kura.

Spanish

Te Reo Pāniora

Spanish is the third most widely spoken language and is used by over 500 million people in Spain and both North and South America. By studying Spanish, students gain insight into a rich history and a variety of cultures and societies that have spanned the globe. Many New Zealanders are choosing to learn Spanish for its importance as both a commercial and cultural language.

PYSP

Primary Spanish

Curriculum Levels 1 & 2

This is a taster course that introduces basic communication in Spanish. In the course, students learn how to greet people, ask where someone is from, talk about family, ask about and give the time as well as talk about other everyday topics.

This course is only available to full-time Year 7 and 8 students and fee-paying students. Students registered in this course are required to work online on My Te Kura.

Recommended prior learning: No prior learning needed.

This course is accessed through our online learning environment – My Te Kura.

SP000

Beginners' Spanish

Curriculum Levels 1–5

This is a course for beginners. Students are introduced to basic listening, speaking, reading and writing skills using everyday Spanish. They learn how to greet people and communicate basic information about themselves and others including looks, hobbies, birthdays, family and their home.

They also learn to communicate about food, shopping and countries. Students also investigate Hispanic culture, giving them a broad understanding of the different countries where Spanish is spoken and their customs. Communication activities are emphasised throughout.

Recommended prior learning: No prior learning needed.

This course is accessed through our online learning environment – My Te Kura.

Students will be required to make and submit audio and/or video recordings, so a microphone and camera or mobile device are required.

SPI000

Spanish

NCEA Level 1 (course endorsement available)

This course develops the four main language skills: listening, speaking, reading and writing. Students hear and learn the Spanish language as it is spoken in both Spain and Latin America.

Throughout the course, the style remains conversational and learning is set to a backdrop of realistic and everyday situations. From introducing oneself to describing family and friends, this course provides students with the ability to socially converse in basic Spanish.

Other topics covered include holidays and travel, school life and sports and leisure activities.

Recommended prior learning: Previous basic knowledge of Spanish is an advantage but not necessary.

This course is accessed through our online learning environment – My Te Kura.

Students will be required to make and submit audio and/or video recordings, so a microphone and camera or mobile device are required.

Demonstrate understanding of a variety of spoken Spanish texts on areas of most immediate relevance

AS90908 Pr Se So Cr External 5 credits

Give a spoken presentation in Spanish that communicates a personal response

AS90909 Pr Internal 4 credits

Demonstrate understanding of a variety of Spanish texts on areas of most immediate relevance

AS90911 Se External 5 credits

Write a variety of text types in Spanish on areas of most immediate relevance

AS90912 Se Cr Internal 5 credits

SP2000**Spanish**

NCEA Level 2 (course endorsement available)

Over this course students learn how to use Spanish vocabulary, structures and functions to communicate a wide range of language for varying situations. Students further their basic Spanish skills and are able to talk about a wide range of events, express their opinions and make comparisons and contrasts. In turn, they gain the necessary ability to give instructions and make suggestions and expand their knowledge on how to use and distinguish between past, present and future tenses.

Recommended prior learning: NCEA Level 1 Spanish or equivalent.

This course is accessed through our online learning environment – My Te Kura.

Students will be required to make and submit audio and/or video recordings, so a microphone and camera or mobile device are required.

Demonstrate understanding of a variety of spoken Spanish texts on familiar matters

AS91148 Se Cr External 5 credits

Interact using spoken Spanish to share information and justify ideas and opinions in different situations

AS91149 SSe So Cr Internal 5 credits

Give a spoken presentation in Spanish that communicates information, ideas and opinions

AS91150 Internal 4 credits

Demonstrate understanding of a variety of written and/or visual Spanish text(s) on familiar matters

AS91151 Se External 5 credits

Write a variety of text types in Spanish to convey information, ideas, and opinions in genuine contexts

AS91152 Se Cr Internal 5 credits

SP3000**Spanish**

NCEA Level 3 (course endorsement available)

Having an understanding of the cultures that surround a language is integral to communicating in that language. This course focuses on authentic Spanish for conversation in a variety of situations in both Latin America and Spain.

There will be many opportunities to speak Spanish throughout, and language skills are also furthered through exercises in listening for understanding, interest and enjoyment. Reading and writing work also helps students develop an appreciation for both the Spanish language and the culture.

New Zealand Scholarship exams are designed to extend very high-achieving Level 3 students. Those who wish to enter the New Zealand Scholarship exam in this subject must discuss this option with their Te Kura subject teacher.

Recommended prior learning: NCEA Level 2 Spanish or equivalent.

This course is accessed through our online learning environment – My Te Kura. It includes a mix of interactive online modules and downloadable resources in PDF format.

Students will be required to make and submit audio and/or video recordings, so a microphone and camera or mobile device are required.

Demonstrate understanding of a variety of extended spoken Spanish texts

AS91568 External 5 credits

Give a clear spoken presentation in Spanish that communicates a critical response to stimulus material

AS91569 Internal 3 credits

Interact clearly using spoken Spanish to explore and justify varied ideas and perspectives in different situations

AS91570 Internal 6 credits

Demonstrate understanding of a variety of extended written and/or visual Spanish texts

AS91571 External 5 credits

Write a variety of text types in clear Spanish to explore and justify varied ideas and perspectives

AS91572 Internal 5 credits

Technology

Te Mātauranga Hangarau

Students who enjoy designing and making things should enrol in this subject. Technology students can choose to work in food technology, hard materials or fashion/textiles technology. Students use the design process and develop their technological skills in areas that interest them. Technology encourages students to think creatively and design practical solutions to problems they have identified. Students are expected to work with people and with resources in their community so that their projects are meaningful and authentic.

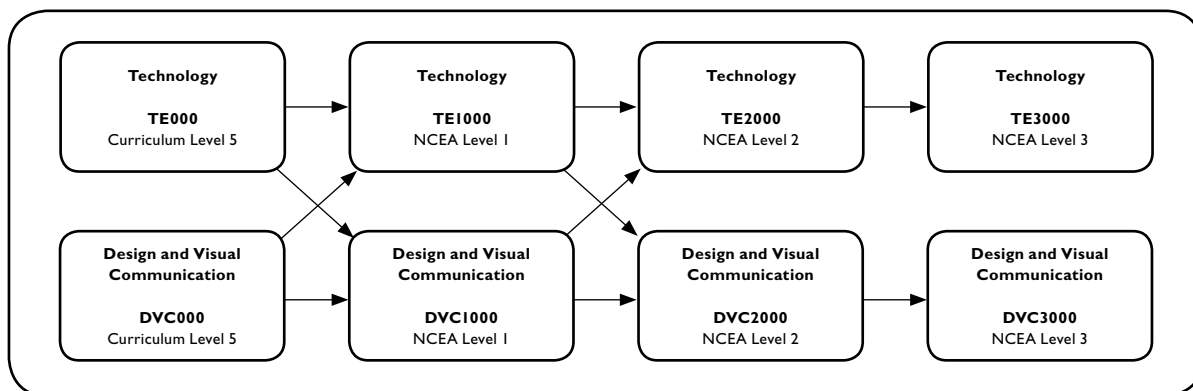

TE000

Technology

Curriculum Level 5

This course offers students a variety of exciting learning opportunities to explore, design and create solutions to authentic practical problems. Students develop their technological practice by a pick and mix of topics from any technological area. They can also specialise in one if they wish.

Topics are based on student interests and help them develop practical technological skills in design and construction. In some topics, wider issues such as sustainability and the impact of technology on the environment and society are introduced.

Students are guided to understand the designer/stakeholder relationship, to identify issues, gather research and think in a visual way as they plan and make in a range of materials.

Recommended prior learning: No prior learning needed.

This course is accessed through our online learning environment – My Te Kura.

TE1000

Technology

NCEA Level 1 (course endorsement available)

This course is for students who like designing and creating practical solutions in real life situations. Technology students work with stakeholders in a setting that interests them.

Technology offers topics in food technology, hard materials and soft materials (fashion/textiles) and students can choose from a number of different topics or they can specialise in one. Worksheets are used to guide students to develop their design, investigation, planning and construction skills.

Students are also encouraged to think creatively and communicate visually as they develop their technological practice and apply their technological knowledge. Individual projects can be developed on request.

Recommended prior learning: No prior learning needed.

This course is accessed through our online learning environment – My Te Kura.

Undertake brief development to address a need or opportunity

AS91044 (1a) Co Ma Pr Se Cr Internal 4 credits

Use design ideas to produce a conceptual design for an outcome to address a brief

AS91046 Co Ma Pr Cr Internal 6 credits

Undertake development to make a prototype to address a brief

AS91047 Co Ma Pr Cr Internal 6 credits

Demonstrate understanding of how technological modelling supports decision-making

AS91048 (la) Co Ma Pr Cr External 4 credits

Implement basic procedures using resistant materials to make a specified product

AS91057 Co Ma Pr Internal 6 credits

Implement basic procedures using textile materials to make a specified product

AS91058 Co Ma Cr Internal 6 credits

Implement basic procedures to process a specified product

AS91082 Ma Pr Se Internal 4 credits

Make basic adaptations to a pattern to enable a design to fit a person or item

AS91096 Ma Cr Internal 4 credits

TE2000

Technology

NCEA Level 2 (course endorsement available)

This course is for students who enjoy innovating and creating practical things. Students chose an area that interests them (food technology, hard materials or fashion and textiles) and work with people to identify real-life opportunities to design, develop and construct technological solutions.

Students work creatively to combine function and aesthetics, and consider a technologist's responsibility to the wider community. Students follow a case study that models the design process and the designer/stakeholder relationship and provides practical teaching and guidance. Students use this case study to develop their understanding of design, visual thinking, investigation, planning and construction. Individual projects can be developed on request.

Recommended prior learning: NCEA Level 1 Technology or equivalent.

This course is accessed through our online learning environment – My Te Kura.

Implement advanced procedures using resistant materials to make a specified product with special features

AS91344 SCo SMa SCr Internal 6 credits

Implement advanced procedures using textile materials to make a specified product with special features

AS91345 SCo SMa SCr Internal 6 credits

Make advanced adaptations to a pattern to change the structural and style features of a design

AS91350 SCo SMa SCr Internal 4 credits

Implement advanced procedures to process a specified product

AS91351 SMa Pr Se Internal 4 credits

Undertake brief development to address an issue

AS91354 (la) Co Ma Pr Cr Internal 4 credits

Develop a conceptual design for an outcome

AS91356 Co Ma Pr SCr Internal 6 credits

Undertake effective development to make and trial a prototype

AS91357 Co SMa Pr SCr Internal 6 credits

Demonstrate understanding of how technological modelling supports risk management

AS91358 (la) Co Ma External 4 credits

TE3000**Technology**

NCEA Level 3 (course endorsement available)

This course challenges students to identify real-life opportunities for innovative design work within their community. A setting is provided, students identify an opportunity that interests them and then choose a context to work in including food technology, hard or soft materials (fashion/textiles). Students frequently work in a combination of these contexts.

This course broadens their experience of the design process from concept to completion. Students work closely with stakeholders as they plan, design and model their concepts before finally creating a solution that is fit for its purpose.

New Zealand Scholarship exams are designed to extend very high-achieving Level 3 students. Those who wish to enter the New Zealand Scholarship exam in this subject must discuss this option with their Te Kura subject teacher.

Recommended prior learning: NCEA Level 2 Technology or equivalent.

This course is accessed through our online learning environment – My Te Kura.

Undertake brief development to address an issue within a determined context

AS91608 (la) Internal 4 credits

Develop a conceptual design considering fitness for purpose in the broadest sense

AS91610 (la) Internal 6 credits

Develop a prototype considering fitness for purpose in the broadest sense

AS91611 (la) Internal 6 credits

Demonstrate understanding of how technological modelling supports technological development and implementation

AS91612 (la) UElwa External 4 credits

Undertake a critique of a technological outcome's design

AS91617 (la) UElwa External 4 credits

Implement complex procedures to integrate parts using resistant materials to make a specified product

AS91620 Internal 6 credits

Implement complex procedures using textile materials to make a specified product

AS91621 Internal 6 credits

Implement complex procedures to create an applied design for a specified product

AS91623 Internal 4 credits

Draft a pattern to interpret a design for a garment

AS91626 Internal 6 credits

Implement complex procedures to process a specified product

AS91643 (la) Internal 6 credits

Te Reo Māori

Te Reo Māori

Māori is one of the official languages of New Zealand and is an integral part of the country's culture. There are numerous reasons to learn Māori including personal enjoyment or career requirements. Whatever the reason may be, learning Māori provides great satisfaction, a greater connection with New Zealand and an enhanced understanding of our culture and society.

PYTREO

Ka Mau Te Wehi

Curriculum Level 1

This is a Year 7 te reo Māori course. It is offered as an online course or as a DVD/Audio CD booklet course. It is a taster course that introduces te reo Māori with short videos of everyday situations.

In the course students learn how to greet people, introduce people, express likes, count in Māori, talk about time and ask where something is as well as talk about other everyday topics.

Recommended prior learning: No prior learning needed.

This course is accessed through our online learning environment – My Te Kura.

MA000

Beginners' Māori

Curriculum Levels 1–5

This is a course for beginners. Students are introduced to basic listening, speaking, reading and writing skills using everyday te reo Māori. They learn how to greet people and communicate basic information about themselves and others including weather, colours, birthdays, family and their home. They also learn how to communicate about time, body parts, food, shopping and roles and responsibilities on the marae.

Māori culture is also investigated to give students a broad understanding of the different dialects and customs where Māori is spoken. Communication activities are emphasised throughout.

Recommended prior learning: No prior learning needed.

This is an online course available through our online learning environment – My Te Kura

Students will be required to make and submit video recordings, so a microphone and camera or mobile device are required.

MA1000**Te Reo Māori**

NCEA Level 1 (course endorsement available)

A range of themes and skills will be practised through listening, speaking, reading and writing in Māori. The following topics will be covered: Kei te Kainga, Te Ao Taiohi, Kei te Marae and Kei te Kura. Additional possibilities: Performing Arts offers Dance and Music standards.

Students can be assessed individually, or as part of a group. Students are expected to have two years or more experience in Te Reo Māori and/or Māori Performing Arts or Dance or Music.

Recommended prior learning: Students are required to have two or more years experience in Māori language.

This course is accessed through our online learning environment – My Te Kura.

Students will be required to make and submit video recordings, so a microphone and camera or mobile device are required.

Whakarongo kia mōhio ki te reo o tōna ao

AS91085 (la) Pr Se So Cr Internal 6 credits

Korero kia whakamahi i te reo o tōna ao

AS91086 (la) Pr Se So Cr Internal 6 credits

Panui kia mōhio ki te reo o tōna ao

AS91087 (la) Pr Se So Cr External 6 credits

Tuhi i te reo o tōna ao

AS91088 (la) Pr Se So Cr External 6 credits

Waihanga tuhinga i te reo o tōna ao

AS91089 (la) Pr Se So Cr Internal 6 credits

Perform dance sequences

AS90002 Cr Internal 6 credits

Demonstrate ensemble skills in a dance

AS90859 Cr Internal 4 credits

Demonstrate ensemble skills through performing a piece of music as a member of a group

AS91091 Cr Internal 4 credits

MA2000**Te Reo Māori**

NCEA Level 2 (course endorsement available)

A range of themes and skills will be practised through listening, speaking, reading and writing in Māori. The following topics will be covered: Toku Ao, Te Ao Tangata, Te Ao Whanui and He Mahi Whakangungu.

Additional possibilities: Performing Arts offers Dance and Music standards. Students can be assessed individually, or as part of a group.

Students are expected to have three years or more experience in Te Reo Māori and/or Māori Performing Arts or Dance or Music.

Recommended prior learning: NCEA Level 1 Māori or equivalent.

This course is accessed through our online learning environment – My Te Kura.

Students will be required to make and submit video recordings, so a microphone and camera or mobile device are required.

Whakarongo kia mōhio ki te reo o te ao torotoro

AS91284 (la) Pr Se So Cr Internal 4 credits

Korero kia whakamahi i te reo o te ao torotoro

AS91285 (la) Pr SSe So Cr Internal 6 credits

Panui kia mōhio ki te reo o te ao torotoro

AS91286 (la) UEIra Pr Se So Cr External 6 credits

Tuhi i te reo o te ao torotoro

AS91287 (la) UEIwa Pr Se So Cr External 6 credits

Waihanga tuhinga auaha, i te reo o te ao torotoro

AS91288 (la) UEIwa Pr SSe So Cr Internal 6 credits

Perform an ethnic or social dance to communicate understanding of the style

AS91207 SCr Internal 4 credits

Perform a repertoire of dance

AS91209 SCr Internal 6 credits

Demonstrate ensemble skills by performing a substantial piece of music as a member of a group

AS91272 SCr Internal 4 credits

MA3000**Te Reo Māori**

NCEA Level 3 (course endorsement available)

A range of themes and skills will be practised through listening, speaking, reading and writing in Māori. The following topics will be covered: Toku Ao, Te Ao Tangata, Te Ao Whanui and He Mahi Whakangungu.

Additional possibilities: Performing Arts offers Dance and Music standards. Students can be assessed individually, or as part of a group.

Students are expected to have three years or more experience in Te Reo Māori and/or Māori Performing Arts or Dance or Music.

Recommended prior learning: NCEA Level 2 Māori or equivalent. Students are expected to have four years or more experience in Māori language.

This course is accessed through our online learning environment – My Te Kura.

Students will be required to make and submit video recordings, so a microphone and camera or mobile device are required.

Whakarongo kia mōhio ki te reo Māori o te ao whanui
AS91650 (la) Internal 4 credits

Korero kia whakamahi i te reo Māori o te ao whanui
AS91651 (la) Internal 6 credits

Panui kia mōhio ki te reo Māori o te ao whanui
AS91652 (la) UElra External 6 credits

Tuhi i te reo Māori o te ao whanui
AS91653 (la) UElwa External 6 credits

Waihanga tuhinga whai take i te reo Māori o te ao whanui
AS91654 (la) UElwa Internal 6 credits

Tertiary Link/Huarahi Trades Academy

Te Wānanga Hononga/Huarahi

Year 12 and 13 full-time students and full-time young adult students can take a Tertiary Link course. Year 11 students may take up to two Tertiary Link units. These courses are purchased from outside providers and students can gain standards towards National Certificates through these courses.

Year 11–13 full-time students and full-time young adult students can apply for a place in Huarahi Trades Academy. We have partners throughout New Zealand where our students can attend a tertiary programme for one or two days a week working towards a vocational pathway. Most Trades Academy programmes can only be started at the beginning of the year but there is provision with some providers to start mid-year or at any time during the year.

TERTLNK

Tertiary Link

NCEA Levels 1–3

The following options are available.

Automotive – Distance units available from Fairview Educational Services at NCEA Level 1 and 2.

Early Childhood Education – Distance units available from Porse Network at NCEA Levels 2 and 3. Practical experience looking after a child under the age of five years is required either at home or in a workplace. Students can work towards the National Certificate in Early Childhood Education Level 3.

Farm Based Skills – Distance units available from Telford Rural Polytechnic. A wide range of unit standards available at NCEA Levels 2 and 3 in General Agriculture, Vehicles and Machinery, Fencing, Dairy, Deer, Sheep, Cattle, Farming Agrichemicals and pest plant control, Apiculture (Beekeeping), Equine, Horticulture and Forestry.

Travel – Distance units available from NZ School of Tourism at NCEA Levels 2 and 3. Students can gain the National Certificate in Tourism (Introductory Skills) Level 2. Read more on our website www.tekura.school.nz.

Recommended prior learning: No prior learning needed.

HUARAHİ TRADES ACADEMY

Huarahi Trades Academy

NCEA Levels 1–3

Huarahi Trades Academy offers students possibilities for achieving NCEA Level 2 and standards towards a Vocational Pathway endorsement, in partnership with tertiary providers. We have a range of tertiary providers across New Zealand and do our best to offer a course to match your career interests while you also complete your school work.

Not all programmes are offered in all areas so it is worth asking or checking on the Te Kura website. Students can complete the qualifications over one, two or three years, while students remain on target to achieve NCEA Level 2.

Students must complete a registration form, provide the required documentation and in some cases attend an interview.

Trades Academy places are limited. Read more on our website www.tekura.school.nz.

Recommended prior learning: No prior learning needed.

Index

Te Kupu Tohu

A		G	
Accounting	22	Gateway	56
Agriculture	90	General Music	80
Art	24	Geography	57
Art History	28	German	59
B		H	
Beginners' Chinese	36	Health and Physical Education	61, 86
Beginners' French	54	Health Education	61
Beginners' Japanese	68	History	63
Beginners' Māori	104	History England 1558–1660	64
Big Picture	19	History New Zealand in the 19th century	65
Biology	30	Home Economics	66
Business Studies	32	Horticulture	90
C		Huarahi Trades Academy	107
Calculus	76	I	
Chemistry	34	Introducing Science	94
Chinese	36	Introduction	5
Classical Studies	38	Introduction to Primary Production	90
Classics and Religious Studies	38	J	
Commerce Studies	40	Japanese	68
D		K	
Design	27	Ka Mau Te Wehi	104
Design and Visual Communication	42	Kaupapa Māori	70
Digital Technology	44	L	
E		Legal Studies	72
Early Childhood	14	Life Skills	18
Economics	47	M	
English	49	Manaaki Marae	70
Enterprise Studies	53	Mathematics	77
Environment Māori	70	Mathematics and Statistics	74
F		Media Studies	78
French	54	Music	80

P	
Painting	25
Pathways Education	82
Performing Arts	85
Photography	27
Physical Education	86
Physics	88
Pregnancy and Childcare	84
Primary Production	90
Primary Spanish	99
Printmaking	26

R	
Religious Studies	39

S	
Samoan	93
Science	94
Sculpture	26
Social Studies	98
Spanish	99
Special Education/Learning Support	17
STAR	56
Statistics	76
Subjects at a glance	20

T	
Technology	101
Te Reo Māori	104
Tertiary Link	107
Tikanga	71
Tourism Māori	71

V	
Visual Arts	24

Y	
Years 1 to 6	15
Years 7 to 10	16